

Green Chemistry Education Webinar Series

Introduction to Green Engineering

July 29, 2014



Today's Speakers

Julie Zimmerman



Yale University

Associate Professor of
Chemical & Environmental
Engineering, Forestry &
Environmental Studies

Matthew Eckelman



Northeastern University

Assistant Professor of Civil and
Environmental Engineering

Julie Schoenung



**University of California
Davis**

Professor and Vice Chair of
Chemical Engineering and
Materials Science

Green Chemistry and Engineering: The How of Sustainability

Julie Beth Zimmerman, PhD
School of Engineering and Applied Science
School of Forestry and Environmental Studies
Yale University

Doing the right things wrong

- Can we appropriately and successfully address sustainability challenges if our designs are not in themselves sustainable?

Doing the right things wrong

Purifying water with
acutely lethal
substances

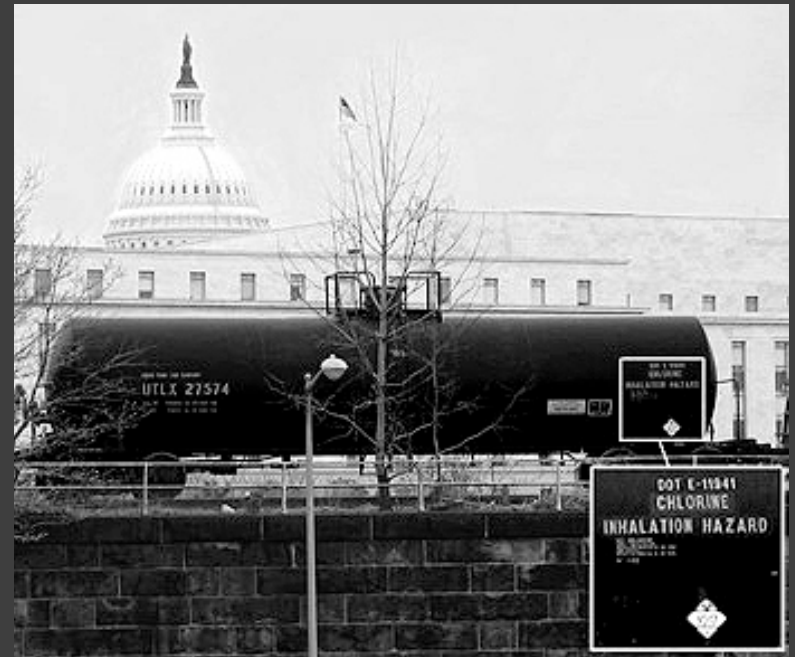

Doing the right things wrong

Precious, rare, toxic
metals in photovoltaics



Doing the right things wrong

Agricultural crop
efficiency from
persistent pesticides



Doing the right things wrong

Energy saving compact
fluorescent light bulbs
reliant on toxic metals



How did we get there?

- ⦿ Urgent and necessary challenges
- ⦿ Noble goals
- ⦿ Exciting science and technology
- ⦿ Best of intentions



energy



climate



toxics



biodiversity



water



New Approach

- ⦿ Innovation based
- ⦿ Solutions oriented
- ⦿ Advancing competitiveness
- ⦿ Intrinsic versus circumstantial
- ⦿ Systematic sustainability

Sustainability

“the design of human and industrial systems to ensure that mankind’s use of natural resources and cycles do not lead to diminished quality of life due either to losses in future economic opportunities or to adverse impacts on social conditions, human health, and the environment”

J.R. Mihelcic, J.C. Crittenden, M.J. Small, D.R. Shonnard, D.R. Hokanson, Q. Zhang, H. Chen, S.A. Sorby, V.U. James, J.W. Sutherland, J.L. Schnoor, *Env. Sci. Tech.* 2003, 37, 5314-5324.

The necessary transformational
change of engineering design

Impacts of Design Decisions

- For a typical product, 70% of the cost of development, manufacture and use is determined in its design phase.
- Analogous for environmental impacts

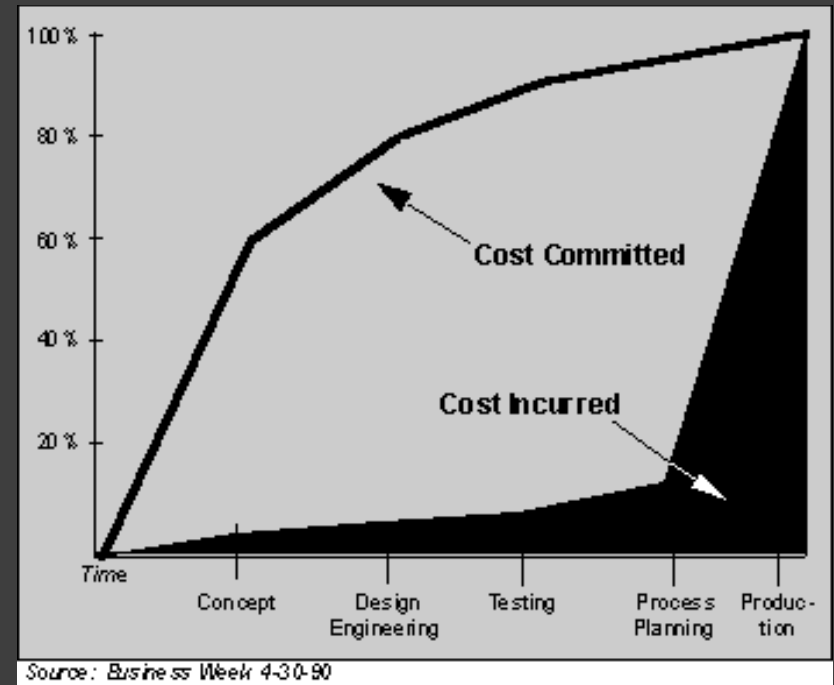

Not just how you design but what you design

Schematic of potential benefits vs. investments

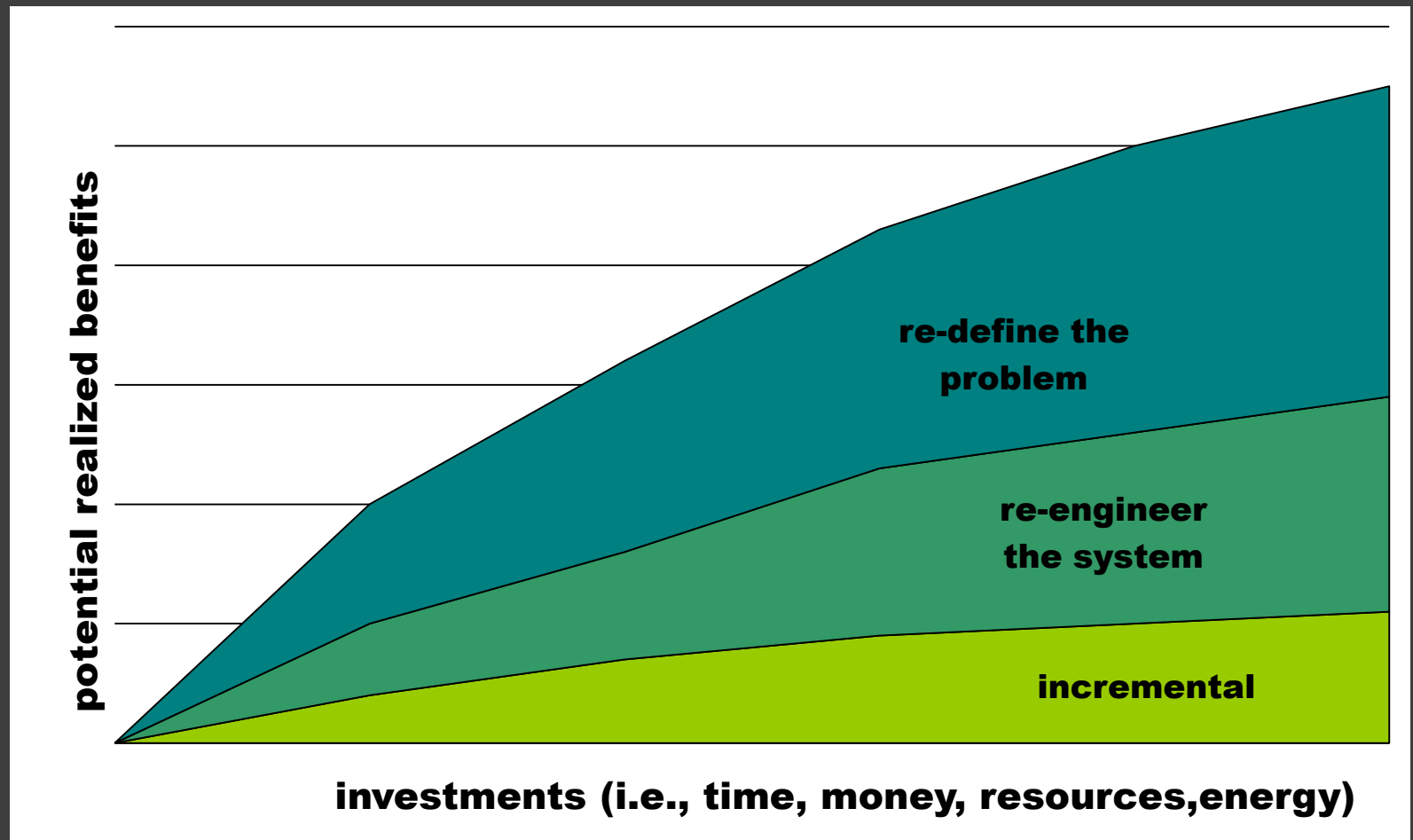

A green frog silhouette is centered on a green background with a wavy, textured pattern. The frog's hands are spread out, and the text "Leap frog or disruptive innovation" is overlaid in white.

Leap frog or disruptive innovation

Sustainability

A small, realistic-looking globe of the Earth is centered in the frame, resting on a bed of vibrant green grass. The globe shows the continents of North and South America in green and brown, surrounded by blue oceans and white clouds. The grass blades are long and thin, creating a textured background.

“Sustainability” without innovation
is....unsustainable.

“Innovation” without sustainability
is....unsustainable.

Biomimicry

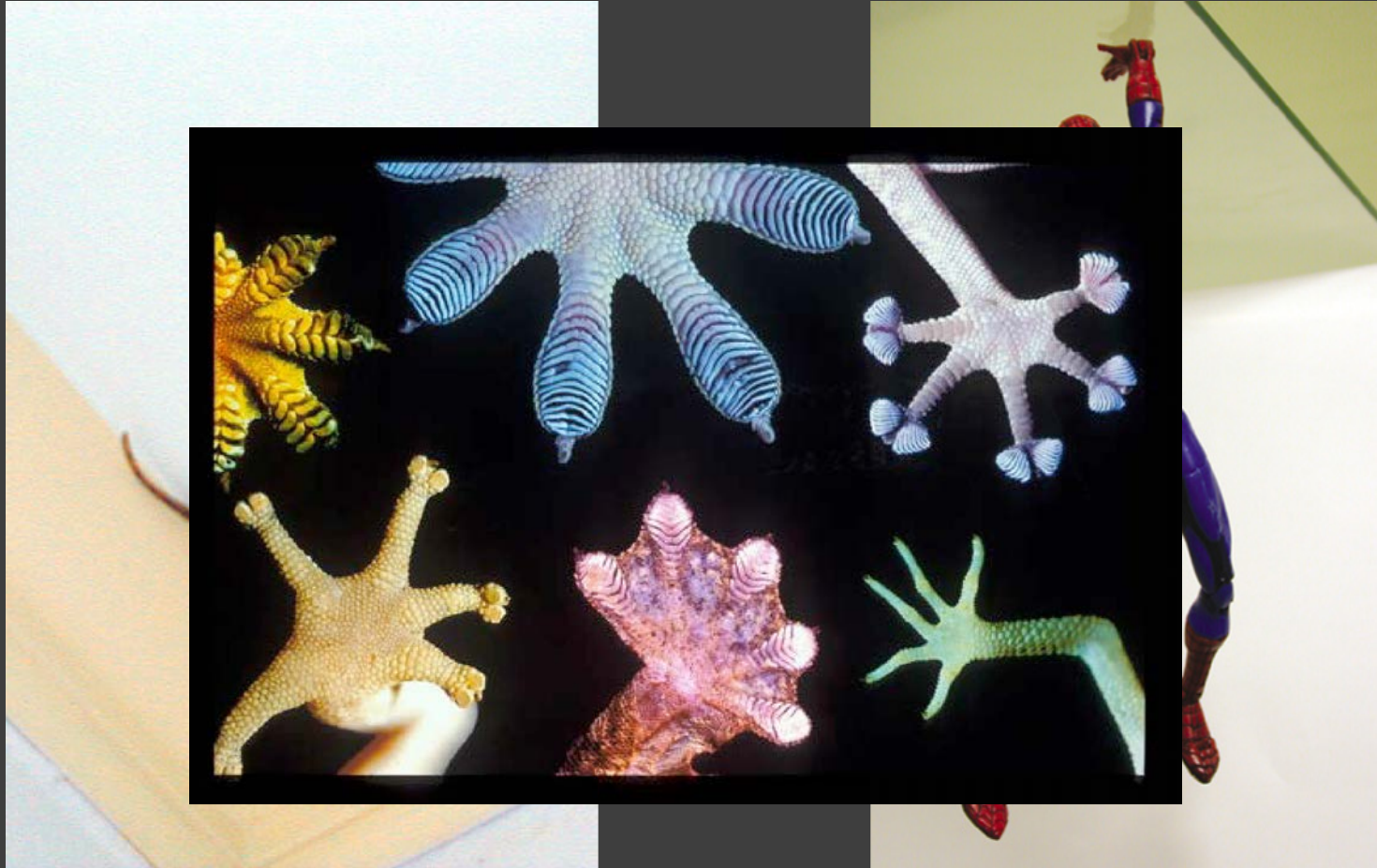

Peacock

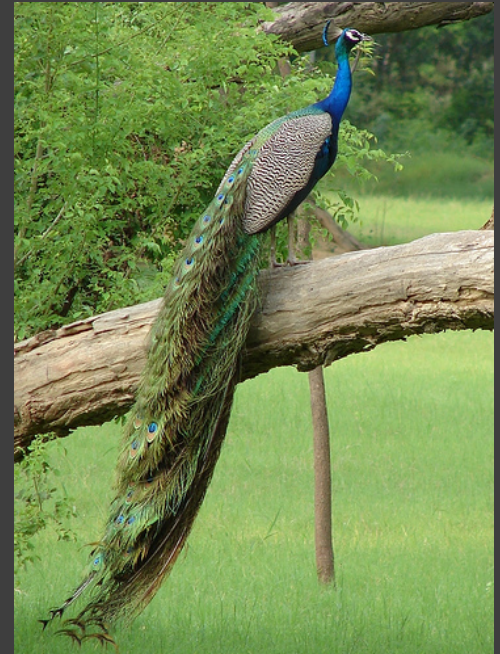
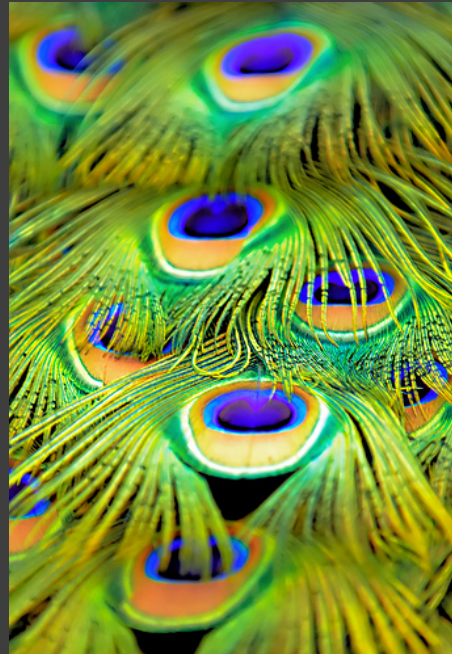

How many chemical pigments are needed to produce this assortment of colors?

None! Color is produced through optical interference arising from the surface structure of the feathers

Textiles...



How many pigments used here?

Textiles...

Textiles Enzymes



- Cellulase Enzymes
- Textile Processing Enzymes

Textiles Finishing Chemicals



- Emulsifiers
 - Paraffins
 - Polyethylene Waxes
- [+ View All](#)

Textiles Coating Chemicals



- Butadiene Polymer
- Styrene Polymers

Textile Pigment



- Carotenoids
 - Chrome Oxide Pigment
 - Fluorescent Pigment
- [+ View All](#)

Textile Polymers



- Acrylic Polymers
- Polyvinyl Alcohol

Textile Pretreatment Chemicals



- Desizing Agents
 - Detergents Agents
 - Optical Brighteners Agents
- [+ View All](#)

Textiles Dyeing Chemicals



- Anti Creasing Agents
 - Defoaming Agent
 - Dispersing Agents
- [+ View All](#)

Textile Dye Chemicals



- Acrylic Dye
 - Cotton Dye
 - Denim Dye
- [+ View All](#)

Textile Colorants



- Direct Dyes
 - Disperse Dyes
 - Reactive Dyes
- [+ View All](#)

Finishing Chemicals



- Flame Retardants

The textiles sector
uses thousands of
chemicals
many of them toxic



Abalone Shell



- **Twice as hard as high-tech ceramics.**
- **Behaves like metal under stress.**

How Industry Makes Ceramics

- **BEAT...** clay to proper consistency.
- **BAKE...** at high temperatures (2000 - 3000 °f).
for prolonged periods (15 – 50 Hours).

(Ceramics Industry Major Contributor To Global Warming)



made by abalone

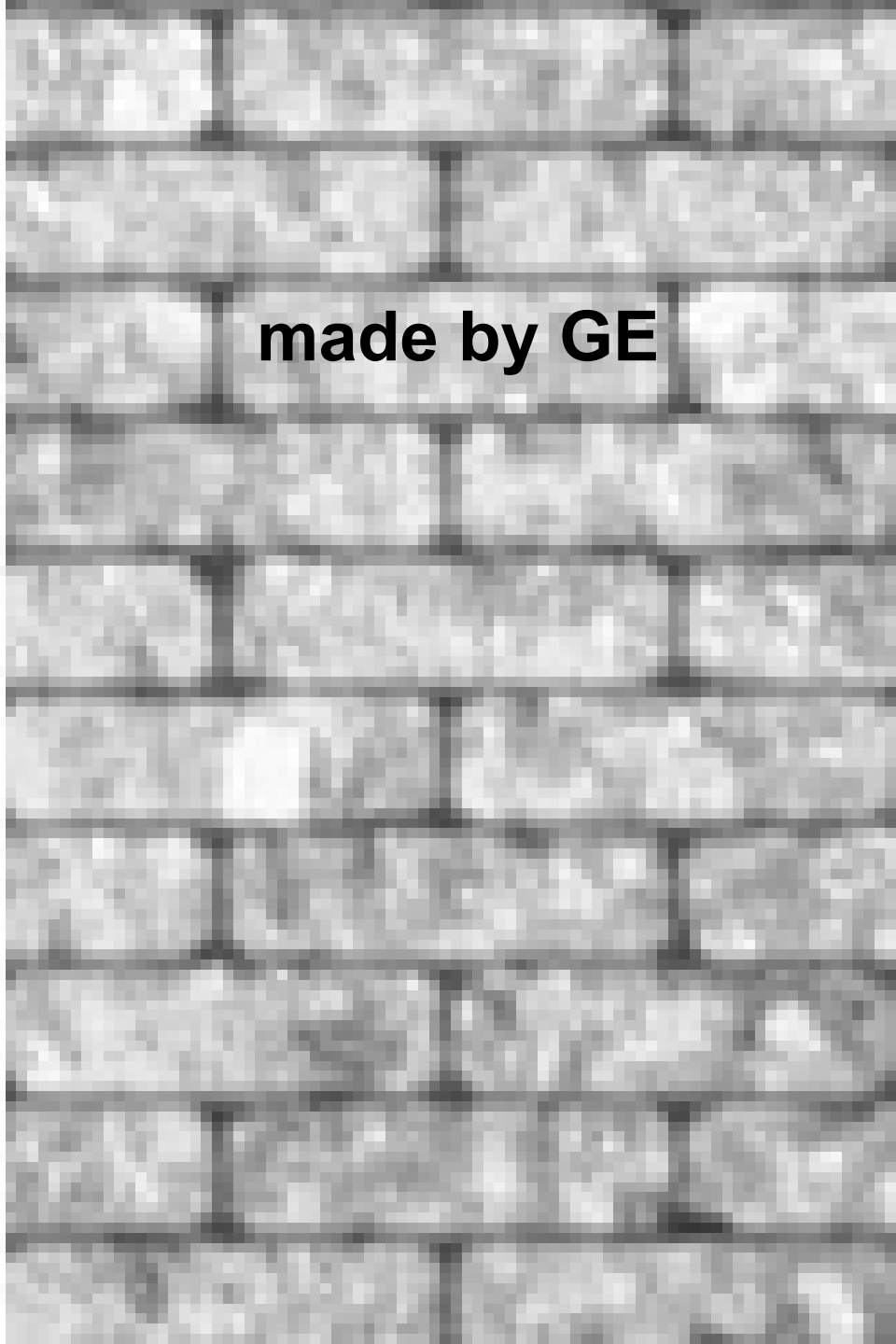

made by GE



Abalone Ceramics Factory



How do we make things?



“Heat, beat, and treat”

How nature makes things...

- * Nature runs on sunlight
- * Nature uses only the energy it needs
- * Nature fits form to function
- * Nature recycles everything
- * Nature rewards cooperation
- * Nature banks on diversity
- * Nature demands local expertise
- * Nature curbs excesses from within
- * Nature taps the power of limits

- Janine Benyus, *Biomimicry*

Systems thinking

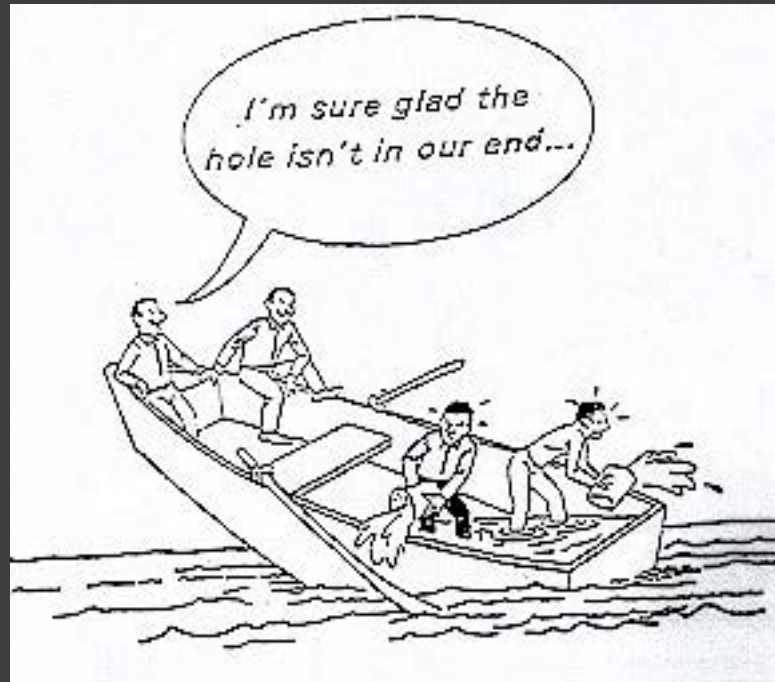

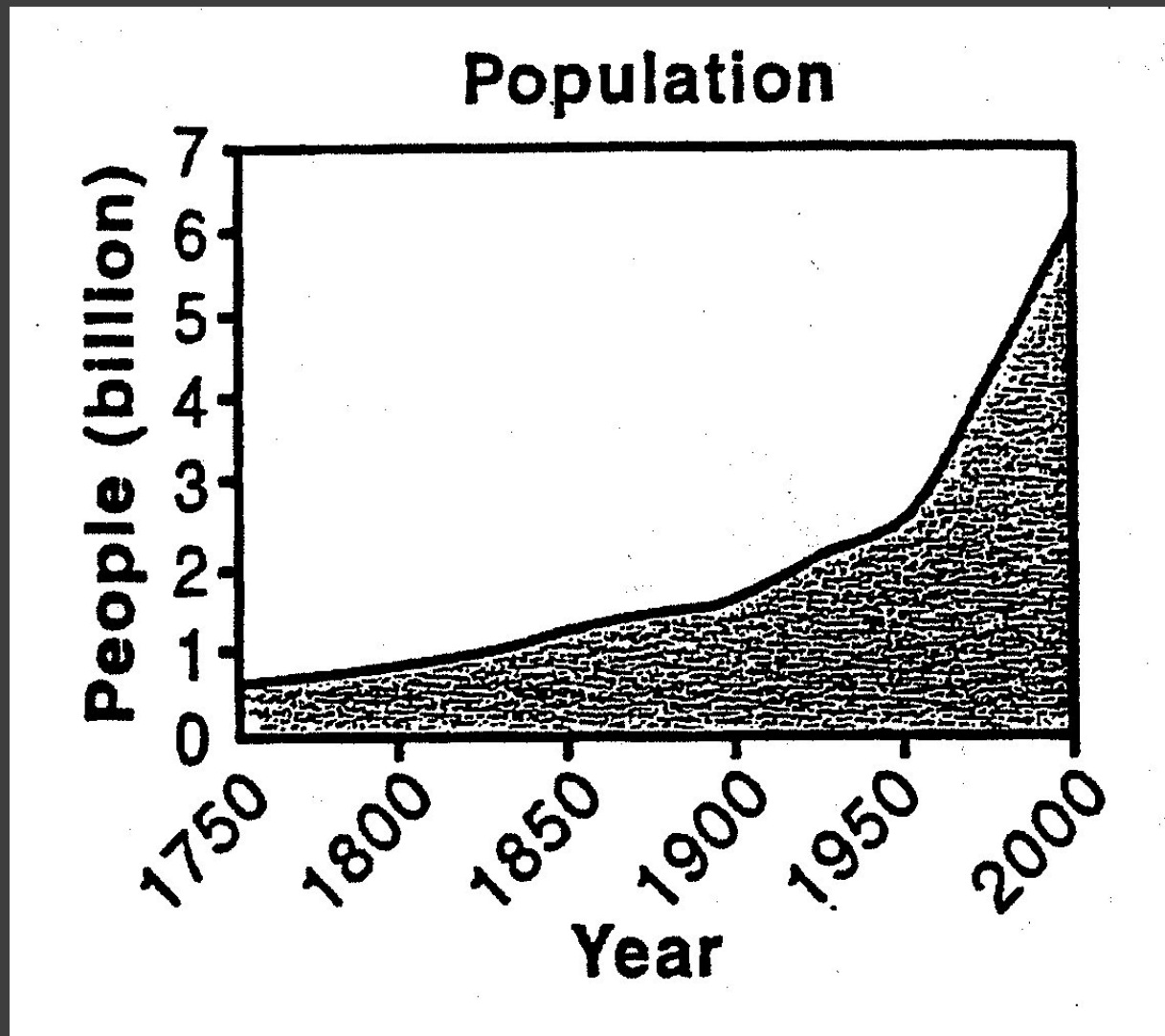

Crutzen, P. J. The Anthropocene: The Current Human-Dominated Geological Era—Human Impacts on Climate and the Environment. In *Climate Change and Its Effect on Sustainable Development, Proceedings of the Global*

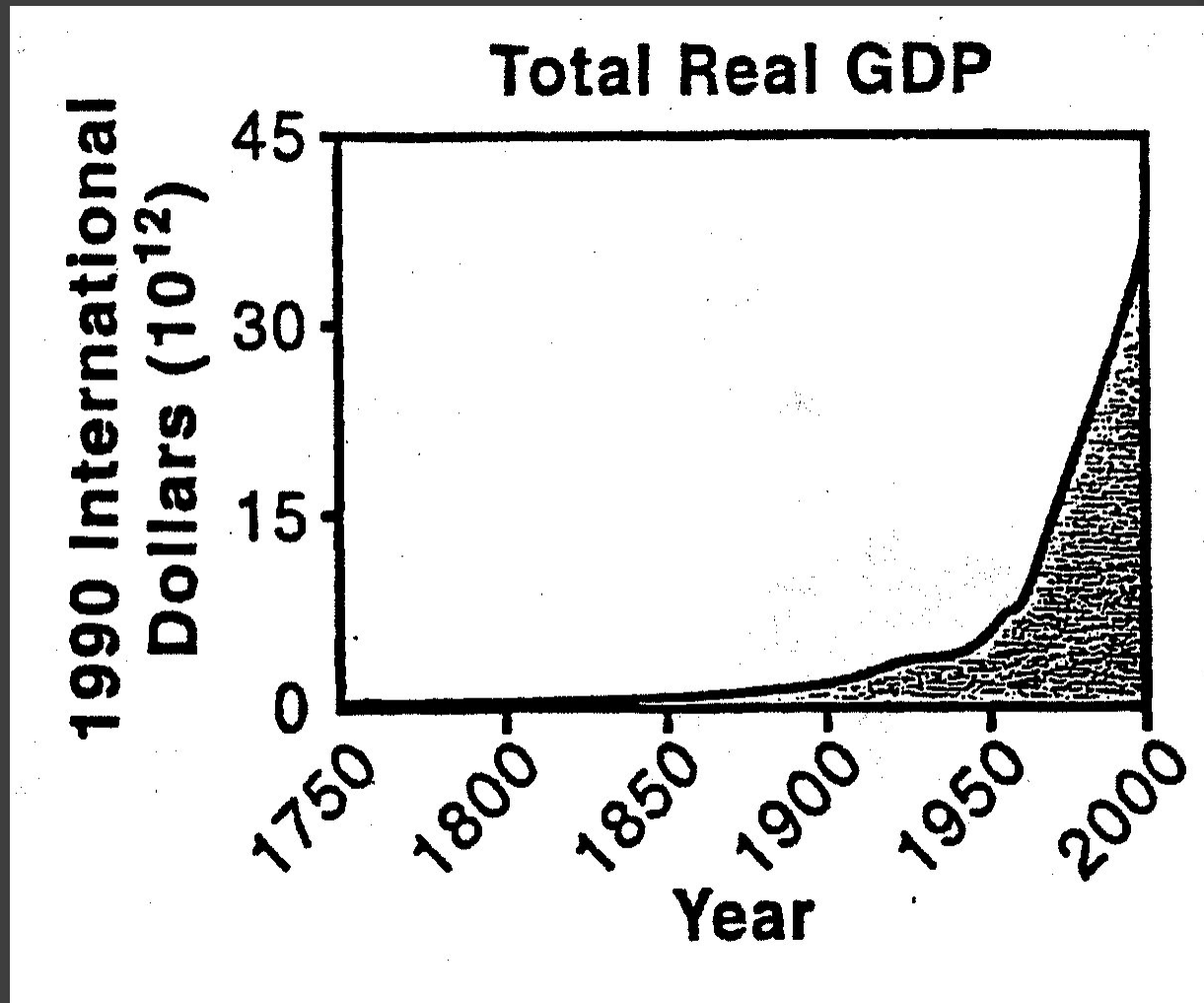

Crutzen, P. J. The Anthropocene: The Current Human-Dominated Geological Era—Human Impacts on Climate and the Environment. In *Climate Change and Its Effect on Sustainable Development, Proceedings of the Global*

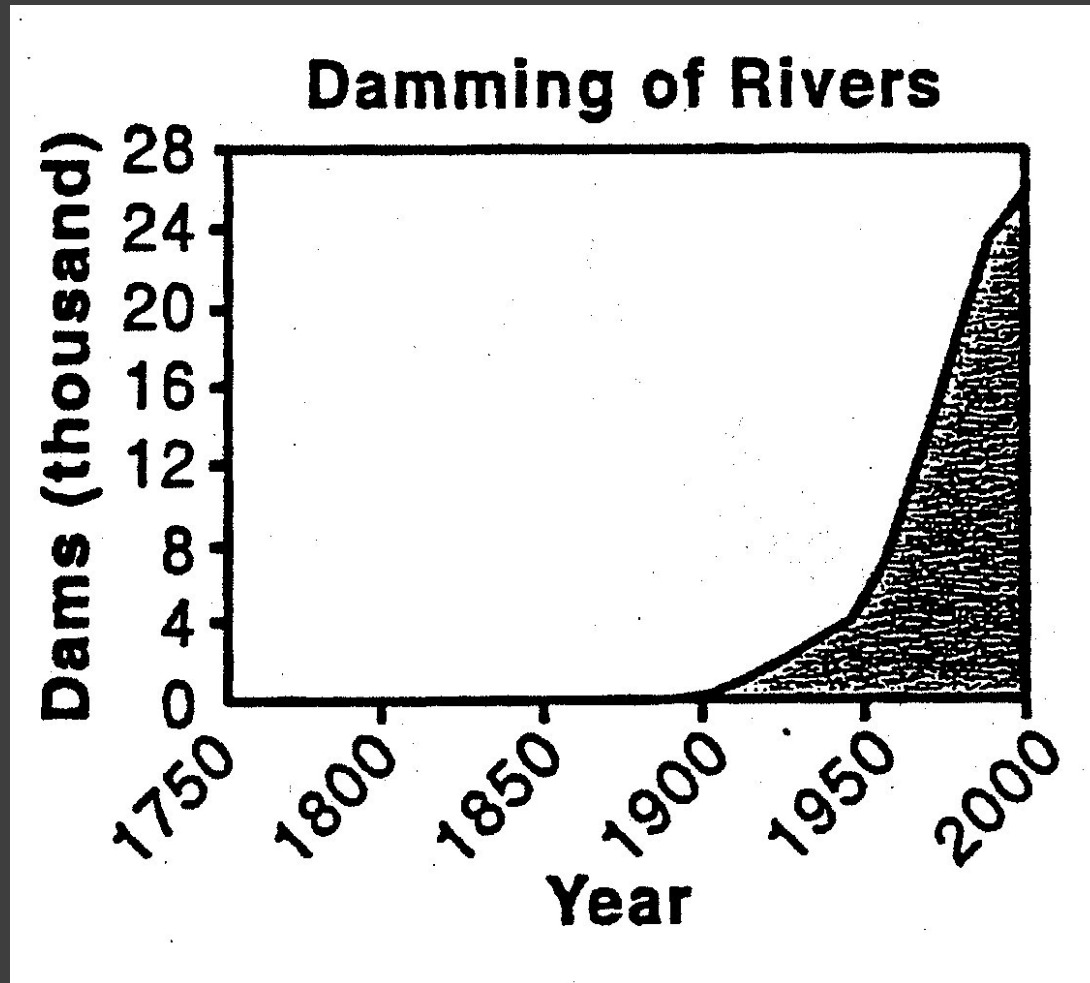

Crutzen, P. J. The Anthropocene: The Current Human-Dominated Geological Era—Human Impacts on Climate and the Environment. In *Climate Change and Its Effect on Sustainable Development, Proceedings of the Global Environmental Action International Conference*, Tokyo, Oct 14–16, 2005; GEA: Tokyo, 2005.

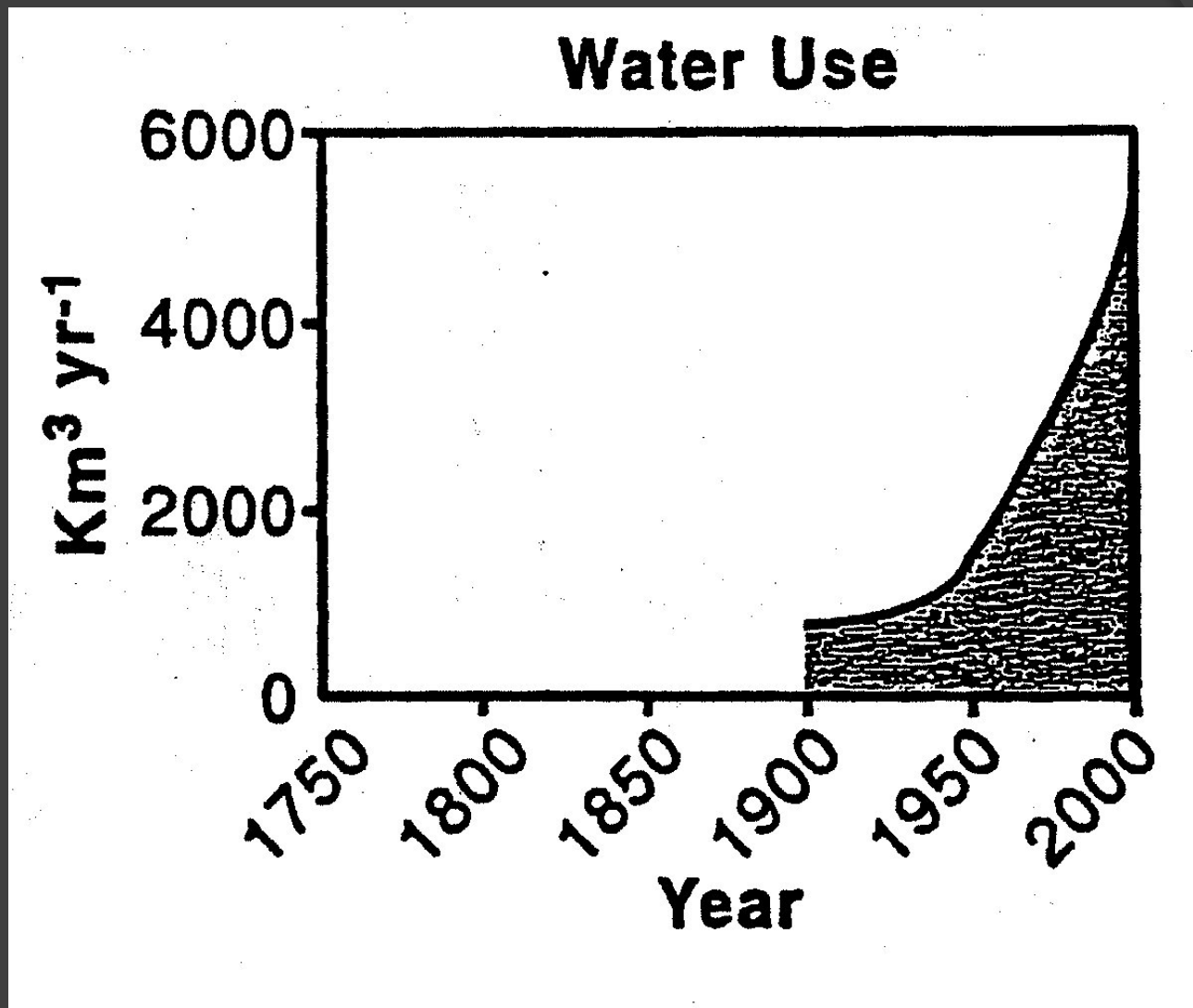

Crutzen, P. J. The Anthropocene: The Current Human-Dominated Geological Era—Human Impacts on Climate and the Environment. In *Climate Change and Its Effect on Sustainable Development, Proceedings of the Global Environmental Action International Conference*, Tokyo, Oct 14–16, 2005; GEA: Tokyo, 2005.

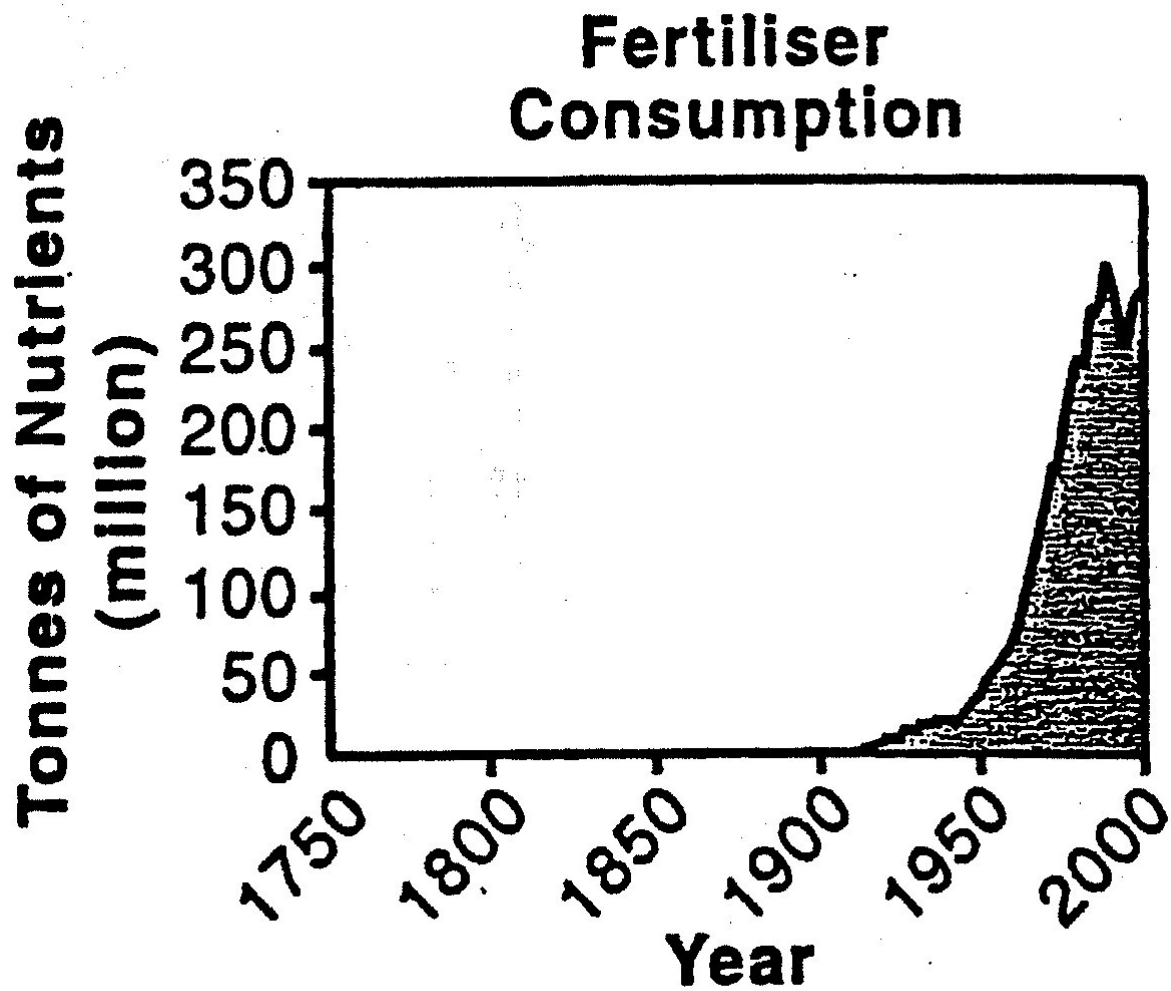

Crutzen, P. J. The Anthropocene: The Current Human-Dominated Geological Era—Human Impacts on Climate and the Environment. In *Climate Change and Its Effect on Sustainable Development, Proceedings of the Global Environmental Action International Conference*, Tokyo, Oct 14–16, 2005; GEA: Tokyo, 2005.

McDonald's Restaurants

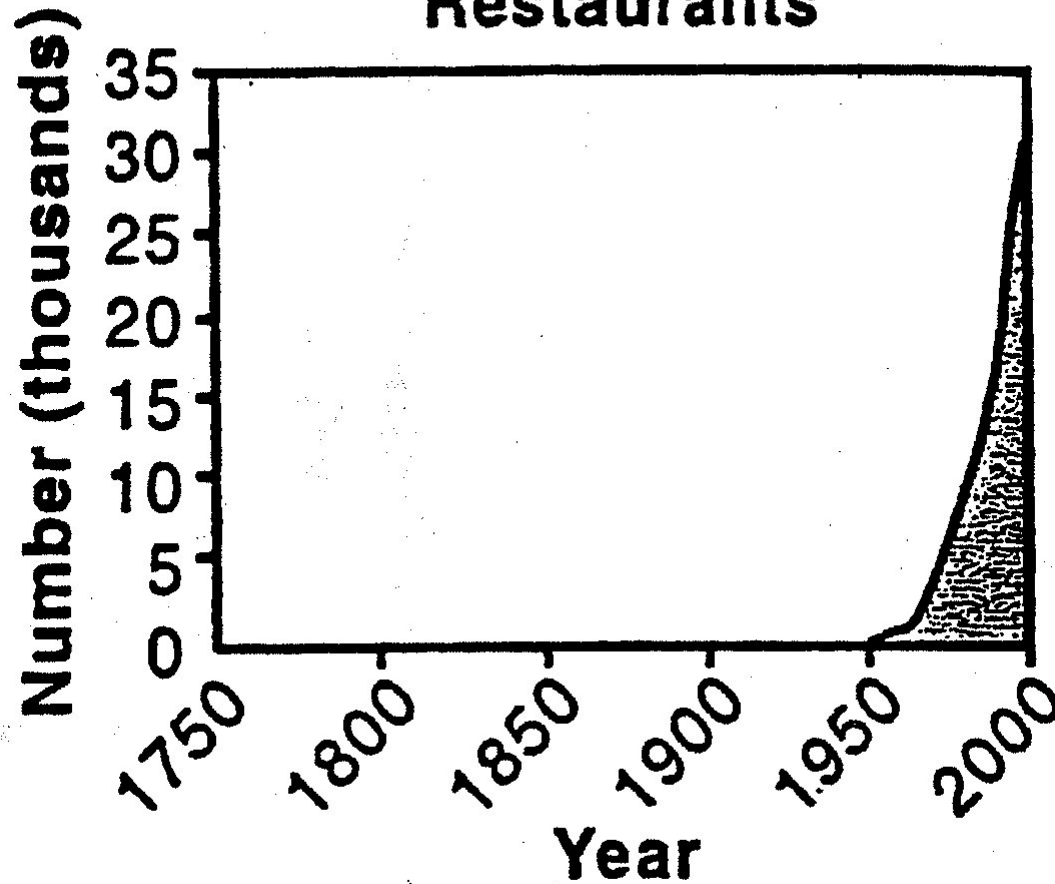

Crutzen, P. J. The Anthropocene: The Current Human-Dominated Geological Era—Human Impacts on Climate and the Environment. In *Climate Change and Its Effect on Sustainable Development, Proceedings of the Global Environmental Action International Conference*, Tokyo, Oct 14–16, 2005; GEA: Tokyo, 2005.

Atmosphere: CO₂ Concentration

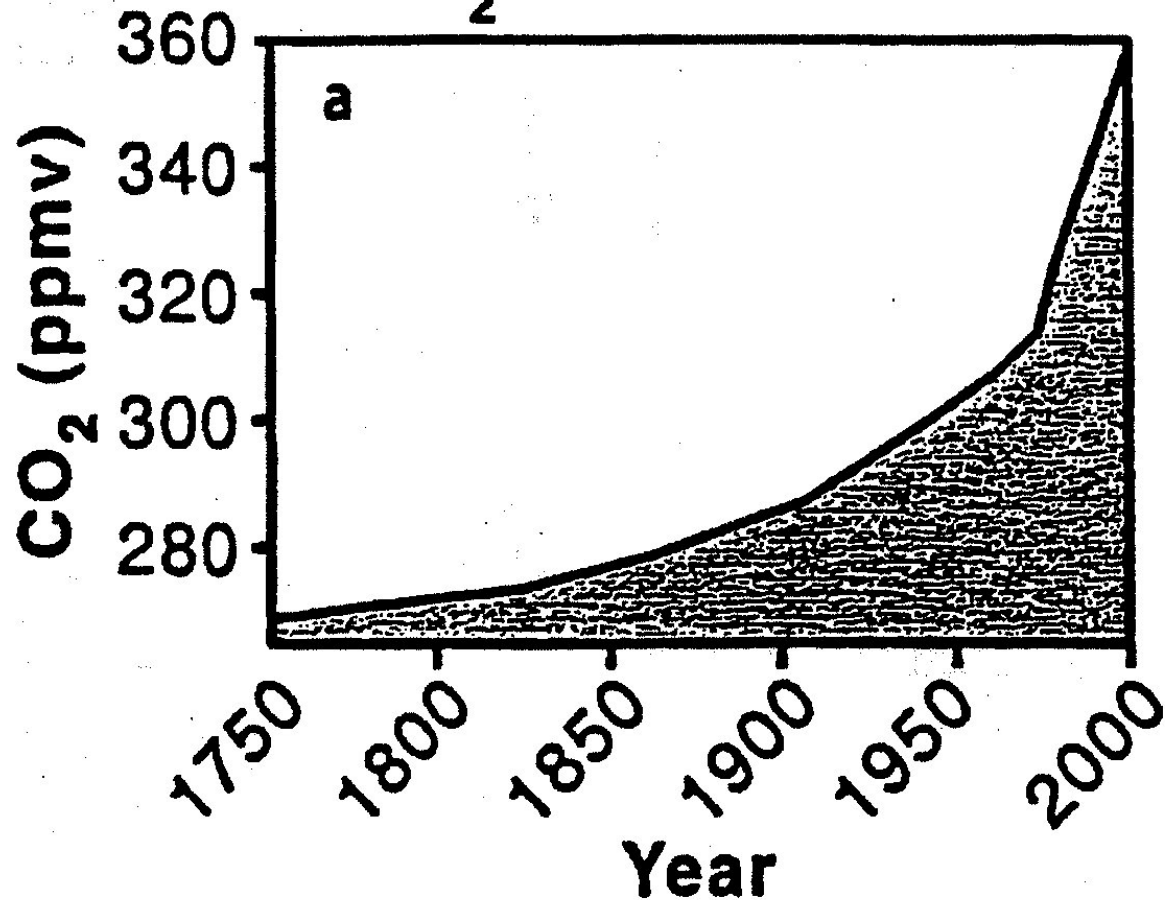

Crutzen, P. J. The Anthropocene: The Current Human-Dominated Geological Era—Human Impacts on Climate and the Environment. In *Climate Change and Its Effect on Sustainable Development, Proceedings of the Global Environmental Action International Conference*, Tokyo, Oct 14–16, 2005; GEA: Tokyo, 2005.

Climate: Great Floods

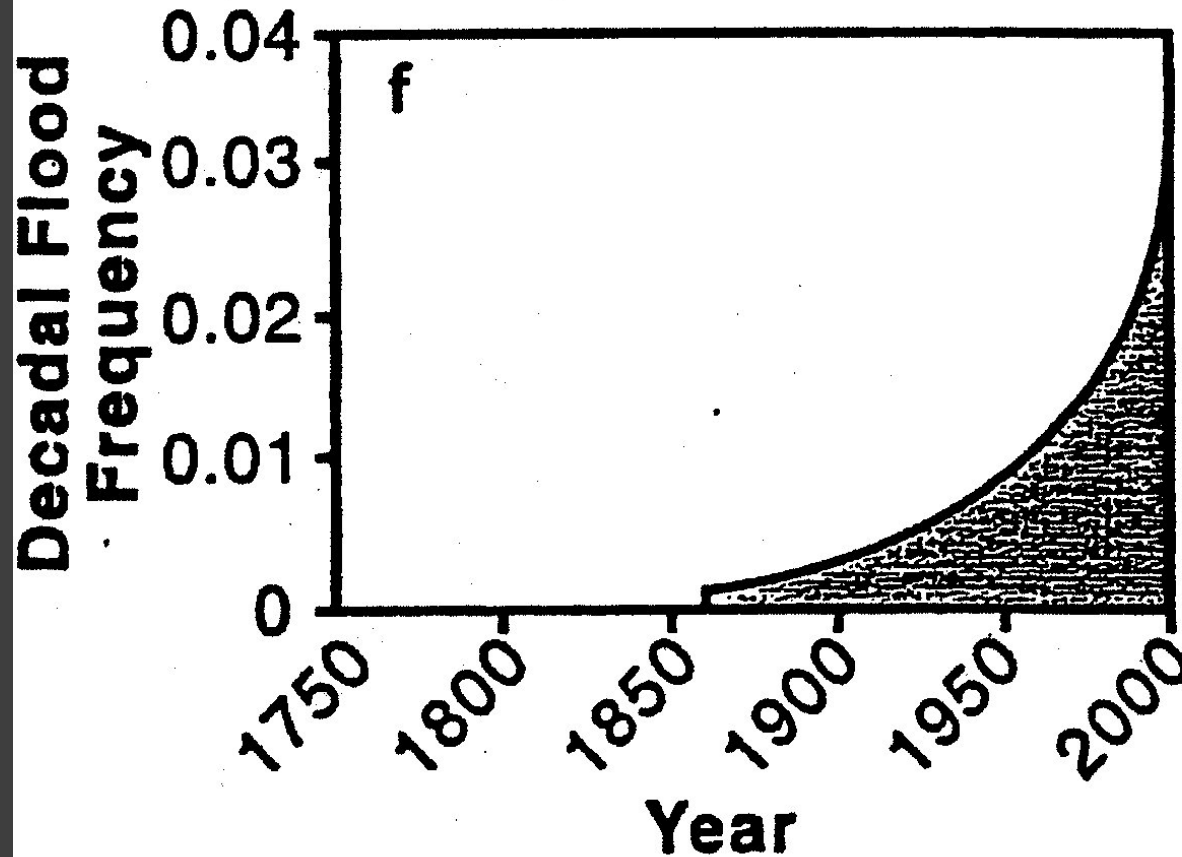

Crutzen, P. J. The Anthropocene: The Current Human-Dominated Geological Era—Human Impacts on Climate and the Environment. In *Climate Change and Its Effect on Sustainable Development, Proceedings of the Global Environmental Action International Conference*, Tokyo, Oct 14–16, 2005; GEA: Tokyo, 2005.

Principles of Green Engineering

1. **Green Chemistry**
2. Prevention rather than treatment.
3. Design for separation.
4. Maximize mass, energy, space, and time efficiency.
5. “Out-pulled” rather than “input-pushed”.
6. View complexity as an investment.
7. Durability rather than immortality.
8. Need rather than excess.
9. Minimize material diversity.
10. Integrate local material and energy flows.
11. Design for commercial “afterlife”.
12. Renewable and readily available.

Anastas and Zimmerman, Environmental Science and Technology, March 1, 2003

View complexity as an investment

- Case for modular, standardized, platform-based, upgradable design

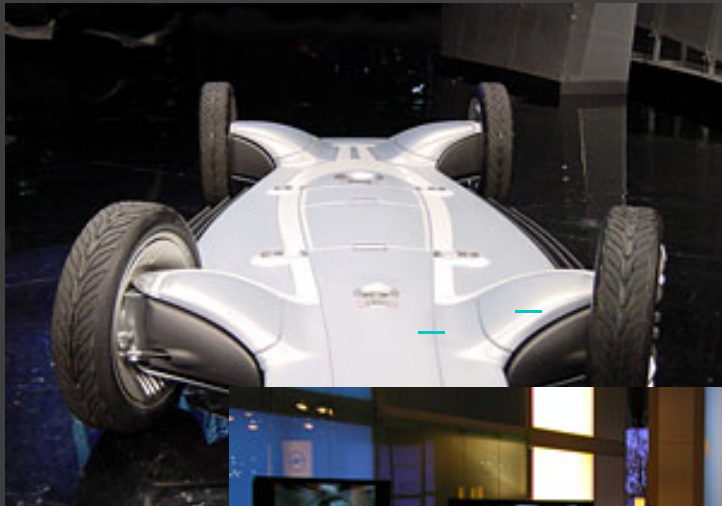

Integrate material and energy flows

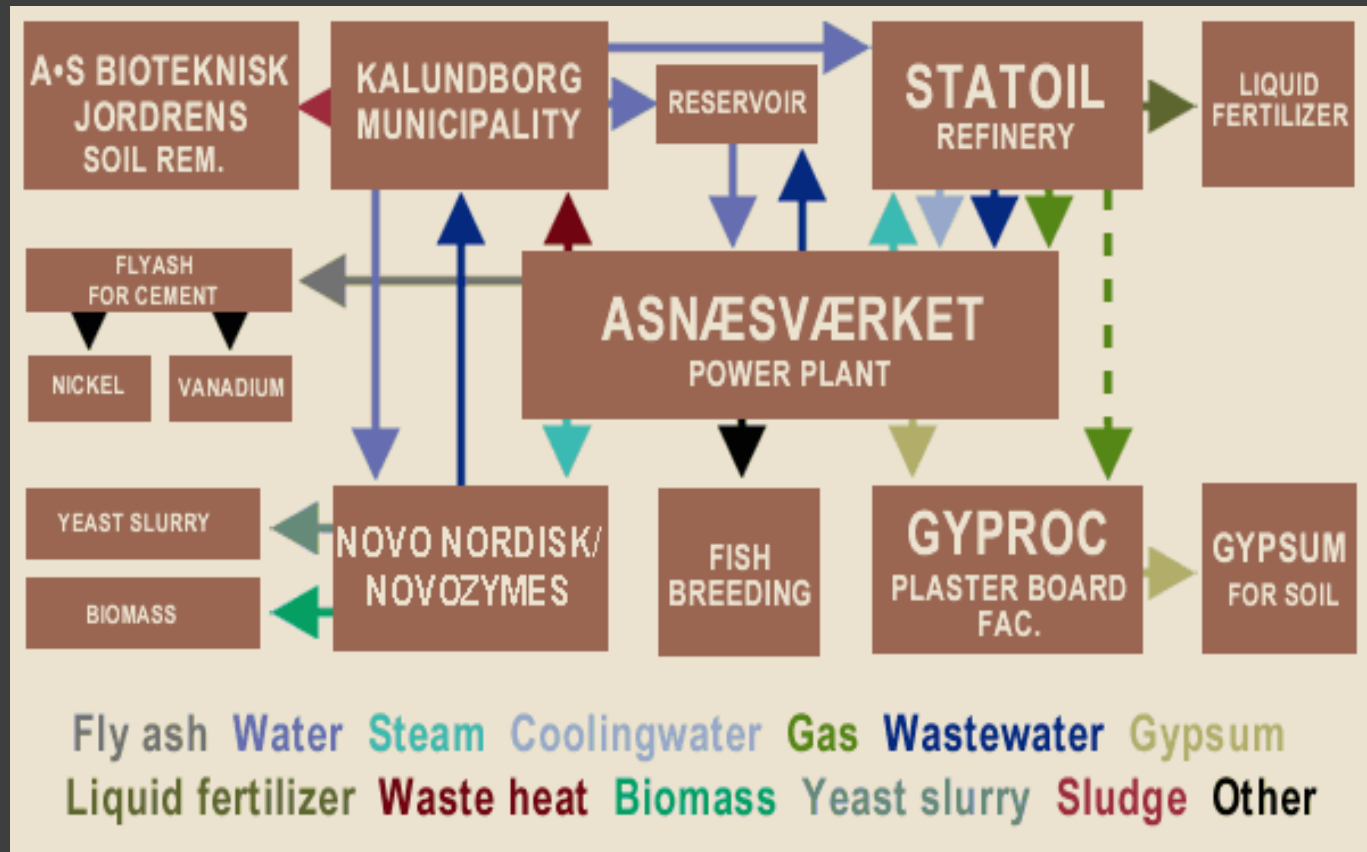

Durability rather than immortality



Design for commercial “afterlife”

"When we reuse our products — much less recycle them — we keep our costs down significantly," says Rob Fischmann, head of worldwide recycling at Lexmark. "The second-time cost for these cartridges is essentially zero."



T65X 36K T65X 25K E362 9K C736 12K C79X 18K

[Click here for a high-res download of this graphic](#)

Renewable and readily available



Ford Looks to Mother Nature to Create Greener, Lighter Plastics



CONCENTRATION OF HARDNESS AS CALCIUM CARBONATE
IN MILLIGRAMS PER LITER

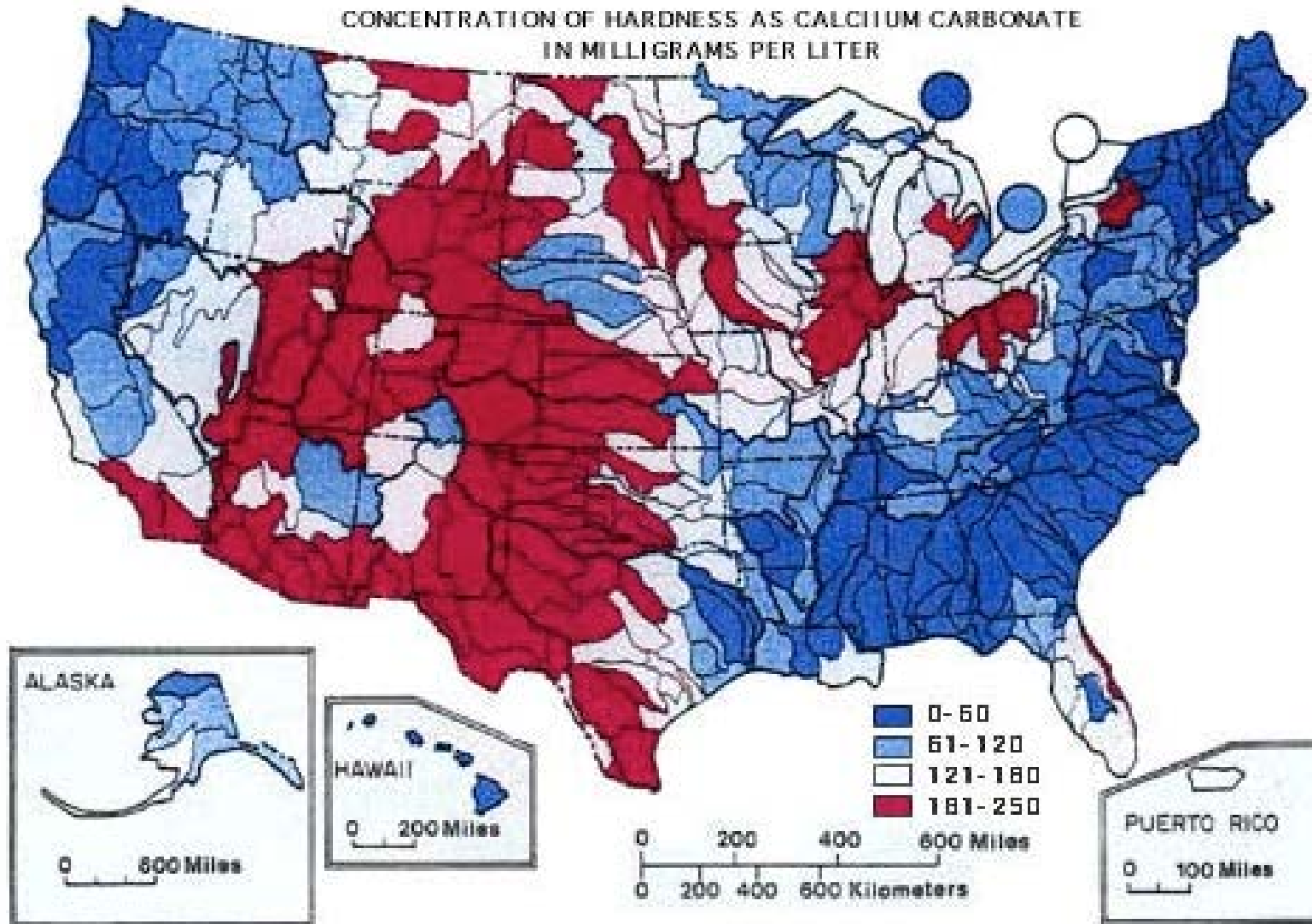

Figure 5.—Mean hardness as calcium carbonate at NASQAN stations during 1975 water year. Map at bottom is colored to show station data representing flow from the accounting unit.

Need rather than excess

Before Eutrophication



After Eutrophication





Key concepts and relation to sustainable design

Fundamental concept: Technologies tend to evolve in similar ways towards “ideality”, where all of the benefits of a product can be achieved while the product itself ceases to exist physically.



What?

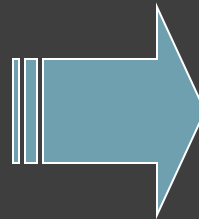

How we typically waterproof surfaces



Lotus flower



Ideality, sustainability, & product design



Coffee decaffeination using methylene chloride



©2002 HawaiiWeb.com

Coffee beans without caffeine

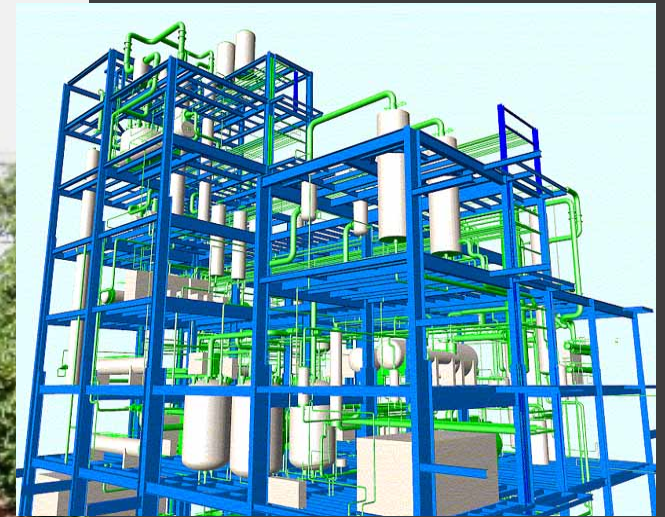

Coffee decaffeination using CO₂ (not a “solvent” by FDA)

Ideality, sustainability, & product design

The task is the cleaning of clothes; current product is detergent.

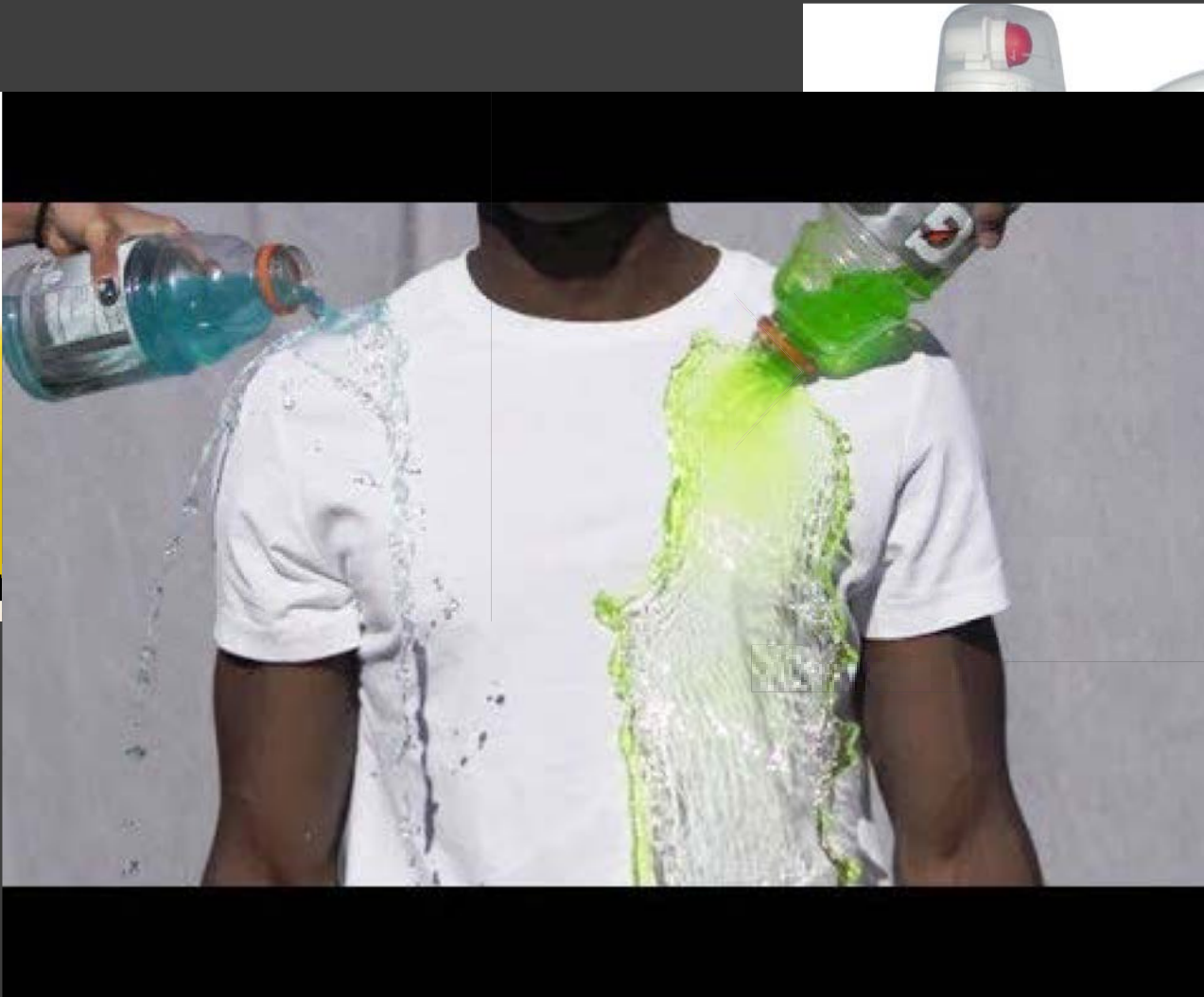

Ideation and Sustainability

The “ideal” solutions do
represent leap-frog innovations

But.....

Corporate structural problems with ideality

- ⦿ Leap-frog may not fit within portfolio – can a detergent company develop self-cleaning clothes?
- ⦿ The will may be present, but the expertise may be lacking.

Leap-frog ideas can create structural problems



A necessary caveat: How do we know our frog is jumping in the right direction?



Some frogs are poisonous ..



Sustainability is a process of continuous improvement, we can't forget to check to make sure we're actually improving.

Measurement Innovation

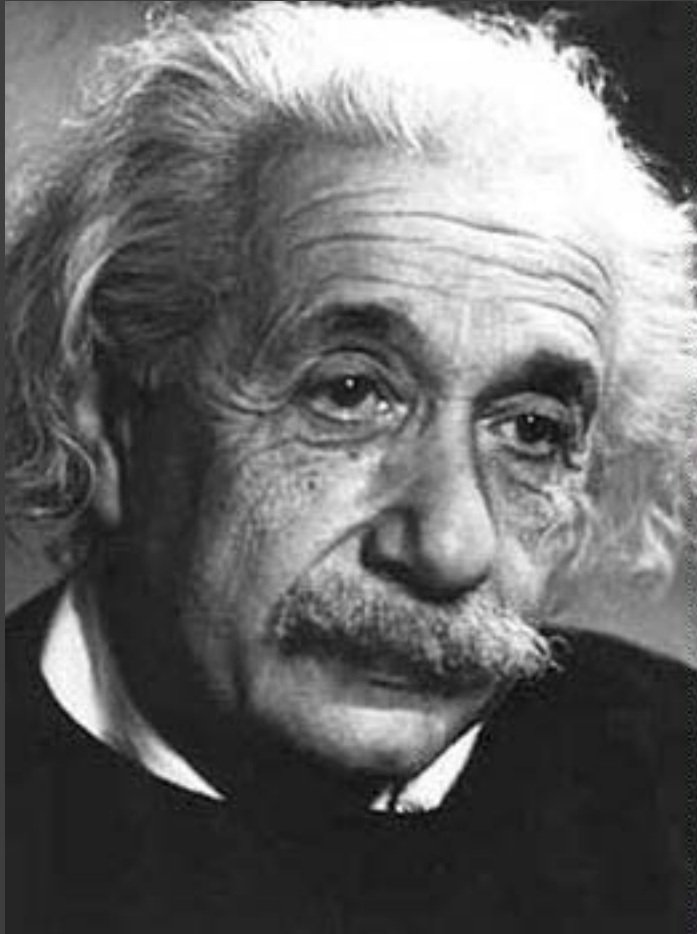

Everything that can be counted does not necessarily count; everything that counts cannot necessarily be counted.

- Albert Einstein

GC3 Webinar on Green Engineering

Matthew Eckelman, PhD

Assistant Professor

Civil & Environmental Engineering

Northeastern University

m.eckelman@neu.edu

July 29, 2014



Principles of Green Engineering

1. Green chemistry.
2. Prevention rather than treatment.
3. Design for separation.
4. Maximize mass, energy, space, and time efficiency.
5. “Out-pulled” rather than “input-pushed”.
6. View complexity as an investment.
7. Durability rather than immortality.
8. Need rather than excess.
9. Minimize material diversity.
10. Integrate local material and energy flows.
11. Design for commercial “afterlife”.
12. Renewable and readily available.

Do Principles get us to the Destination?

- ***Design*** principles
- Should produce superior products and projects
- Need to follow up with comprehensive assessment to ensure performance and guard against unintended effects



the road to somewhere, but where?

Life Cycle Assessment (LCA)

Focus Areas of Design Principles

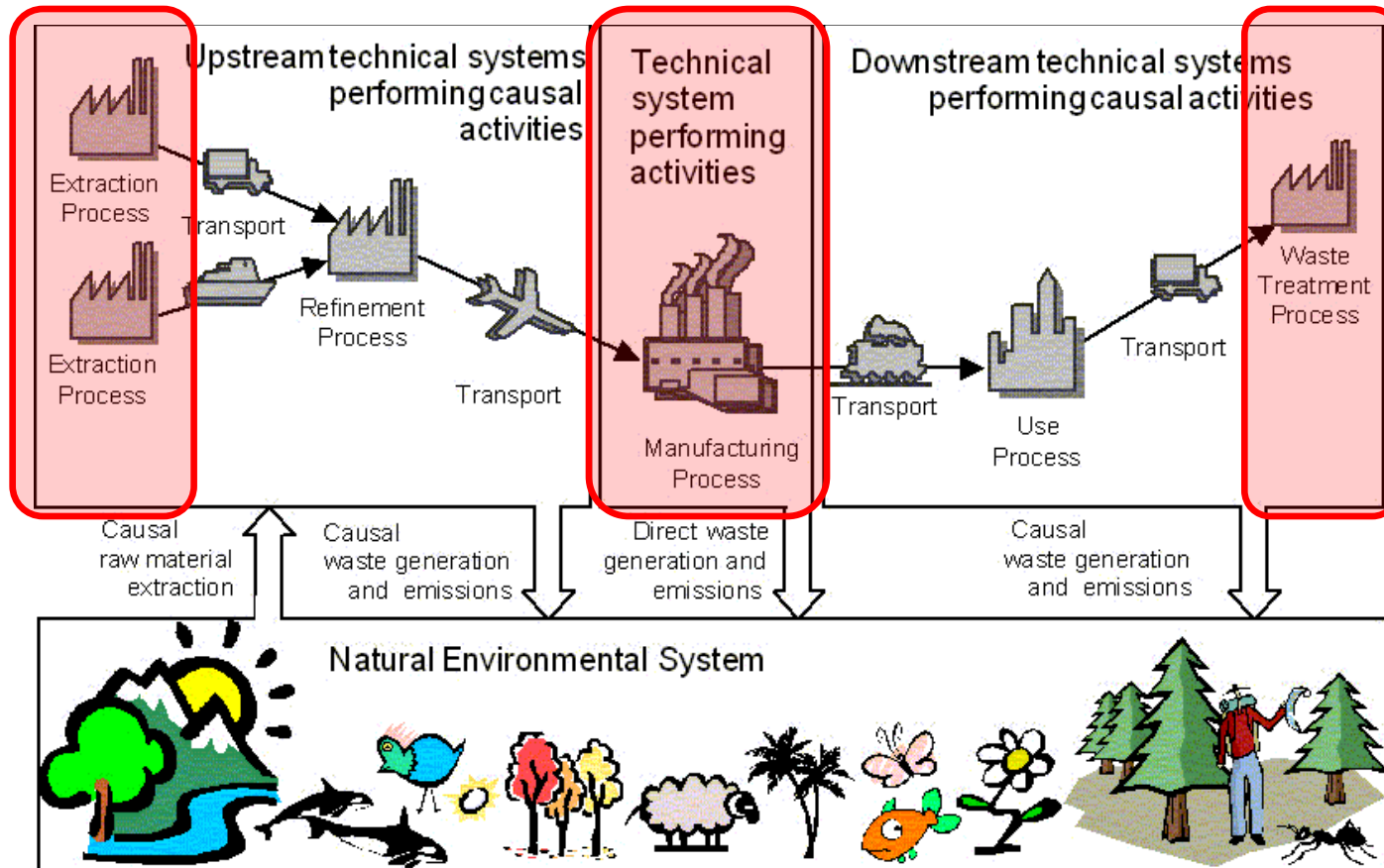

Overview

- Brief Description of LCA Methods
- Case Studies
 - Life cycle mercury emissions from CFLs
 - Use of nanomaterials in electronics
- Efforts to Integrate LCA and Green Chem/Engineering

Life Cycle Assessment (LCA) in Brief

A *systems modeling tool* for characterizing, locating and quantifying the environmental impacts of a product or service

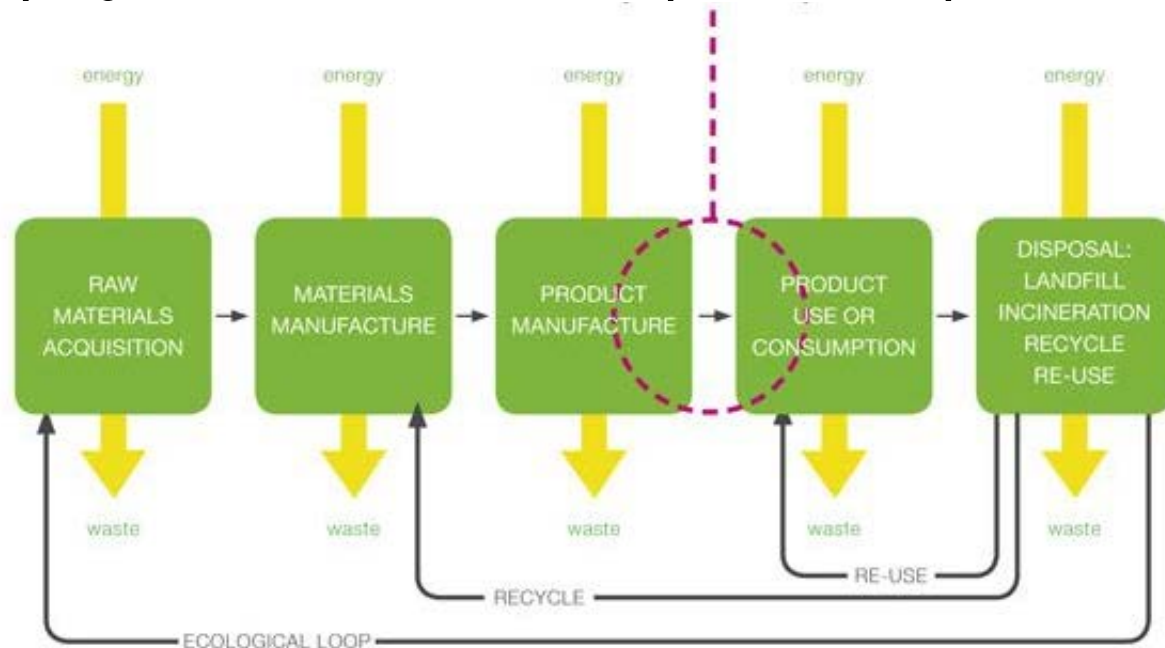

- Environmental impacts can occur at each life cycle stage and be non-intuitive
- Need to consider all stages in order to inform design or policy decisions
- Need to consider multiple environmental impacts, to ensure that we are not simply shifting burdens from one impact to another

Life Cycle Management: Electric Cars

U.S. Electric Power Industry Net Generation by Fuel, 2009

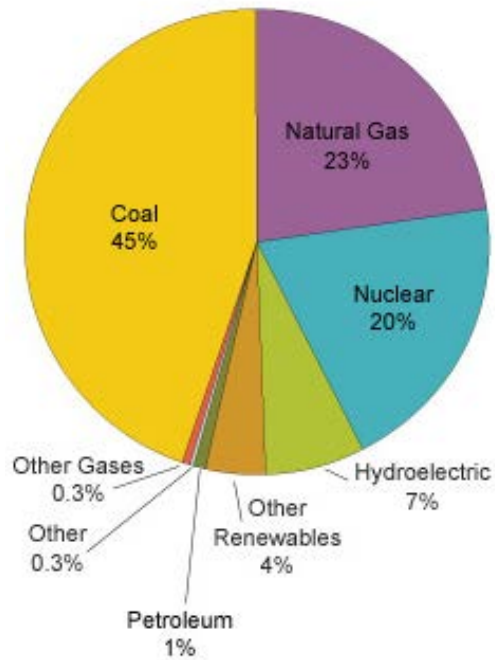

Source: U.S. Energy Information Administration, *Annual Energy Review 2009* (August 2010).



“Its advanced powertrain will deliver significant energy efficiency advantages and zero CO2 emissions without compromising driving enjoyment.”

- Ford, 1/8/11

Life Cycle Assessment Steps

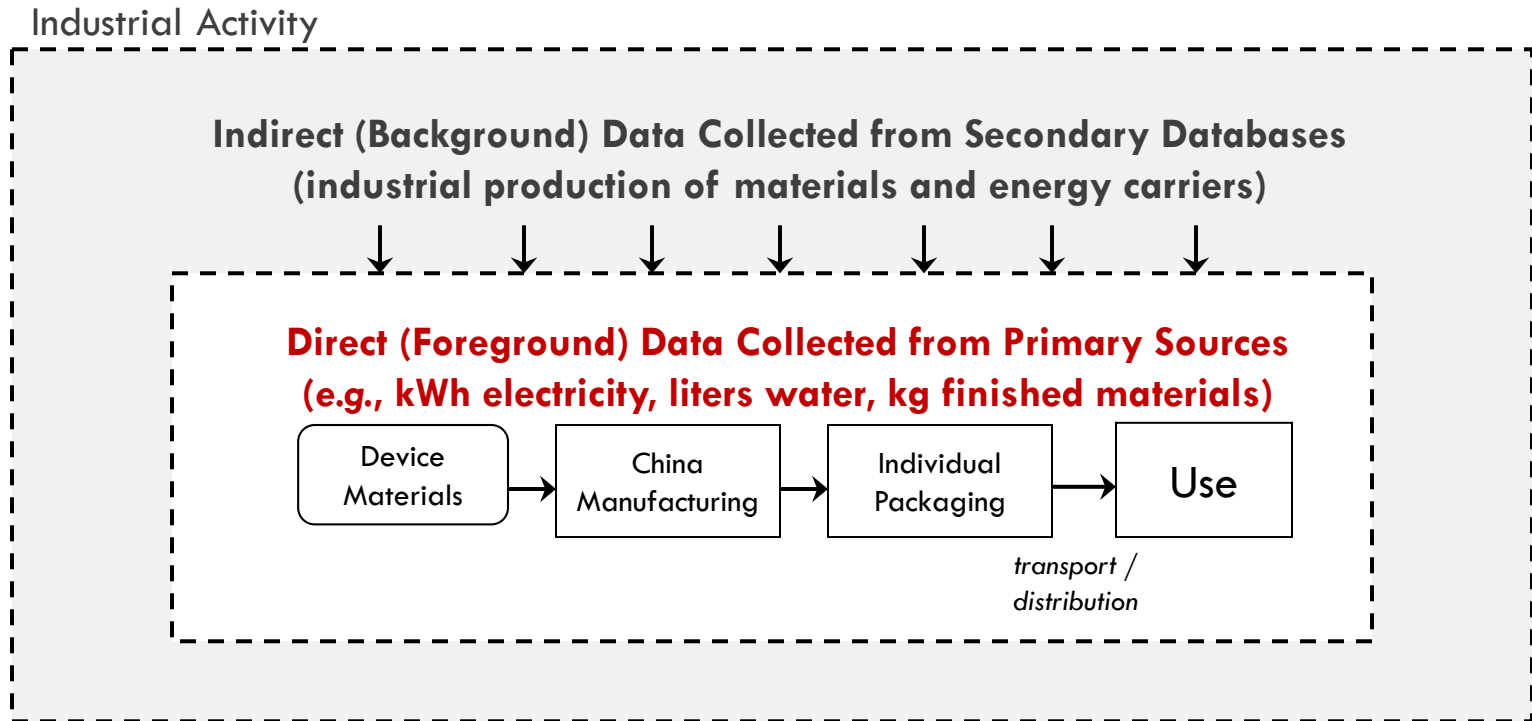

Assemble into a Life Cycle Inventory (LCI)

system-wide bill of resource use and **emissions**



Link to Life Cycle Impact Assessment (LCIA)

emission-fate-exposure-effect modeling of impacts



Linking Environmental Impacts to Damages

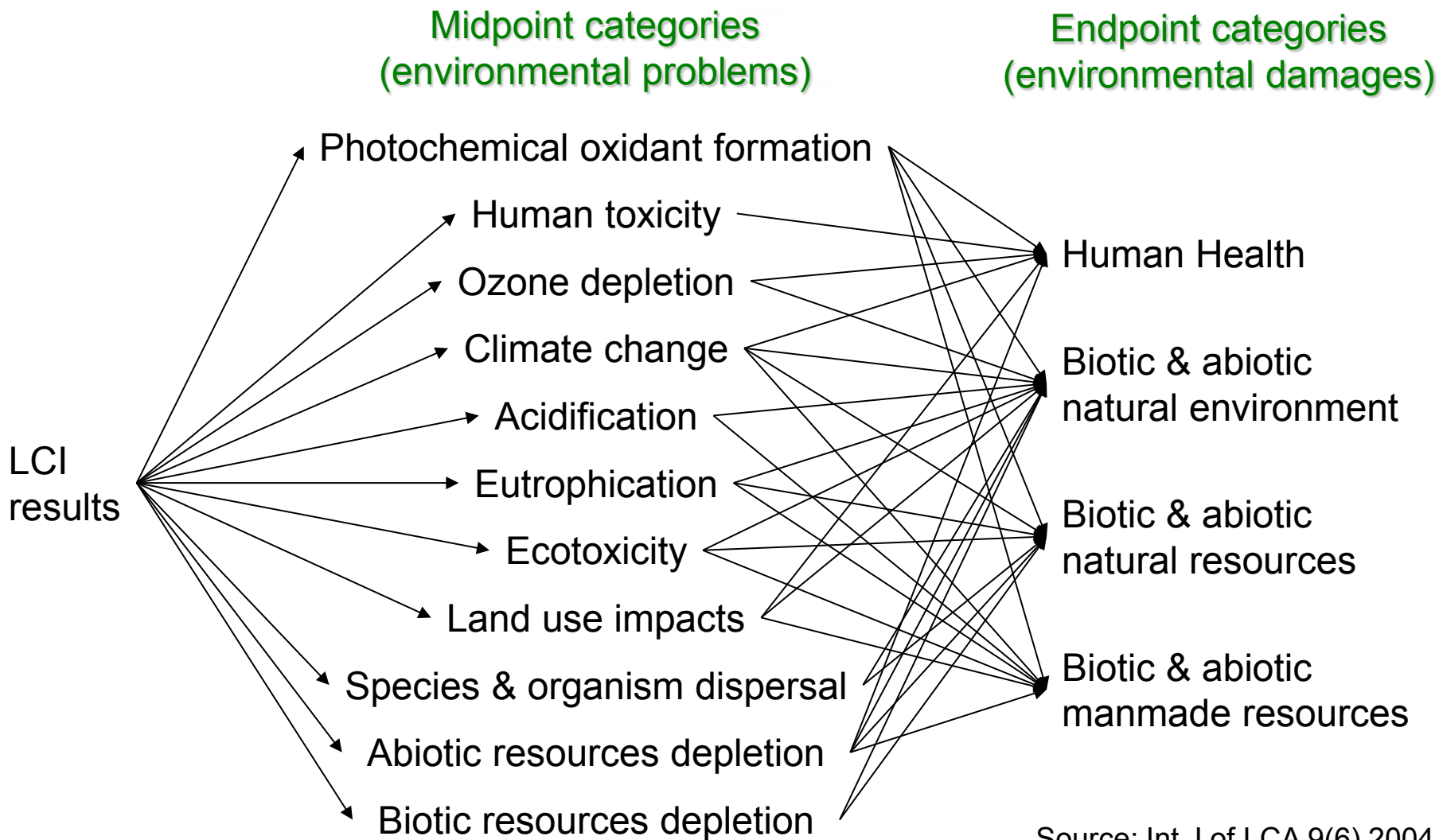

Source: Int J of LCA 9(6) 2004

Ex1 - Mercury Trade-Offs for CFLs

PHILIPS
sense and simplicity

WAL★MART
Save money. Live better.™

SECONDS.ORG
CHANGE A BULB. CHANGE EVERYTHING.

WHAT ARE CFL BULBS & WHY SWITCH ?

United States

CFL LIGHTBULBS PURCHASED SINCE 1/1/07:

145,132,366



EQUIVALENCY:

DOLLARS SAVED: **\$4,285,091,159**

CARS OFF THE ROAD: **1,029,592**

POUNDS OF COAL SAVED: **15,108,686,214**

POUNDS OF CO2 PREVENTED: **64,665,176,995**

**CHANGE A BULB,
CHANGE EVERYTHING**

It only takes **18 seconds** to change a light. Save energy and cash now by switching to Energy Star CFL bulbs, available nearly everywhere light bulbs are sold.



HOW ENLIGHTENED IS YOUR AREA?

low high



SELECT YOUR STATE OR ENTER ZIP FIND IT



The typical home has more than 40 sockets for light bulbs.



Mercury Sources in US



The major sources of atmospheric mercury in the United States are:

Utility boilers	32.8%
MSW combustors	18.7%
Commercial/Ind boilers	17.9%
Medical waste incinerators	10.1%
Chlor-alkali	4.5%
...	...
Fluorescent lamps	1.0%

Total Emissions:
144 Mg/yr

**Mercury Study
Report to Congress**



Volume II:
An Inventory of Anthropogenic
Mercury Emissions in the
United States

Material Flow of Mercury

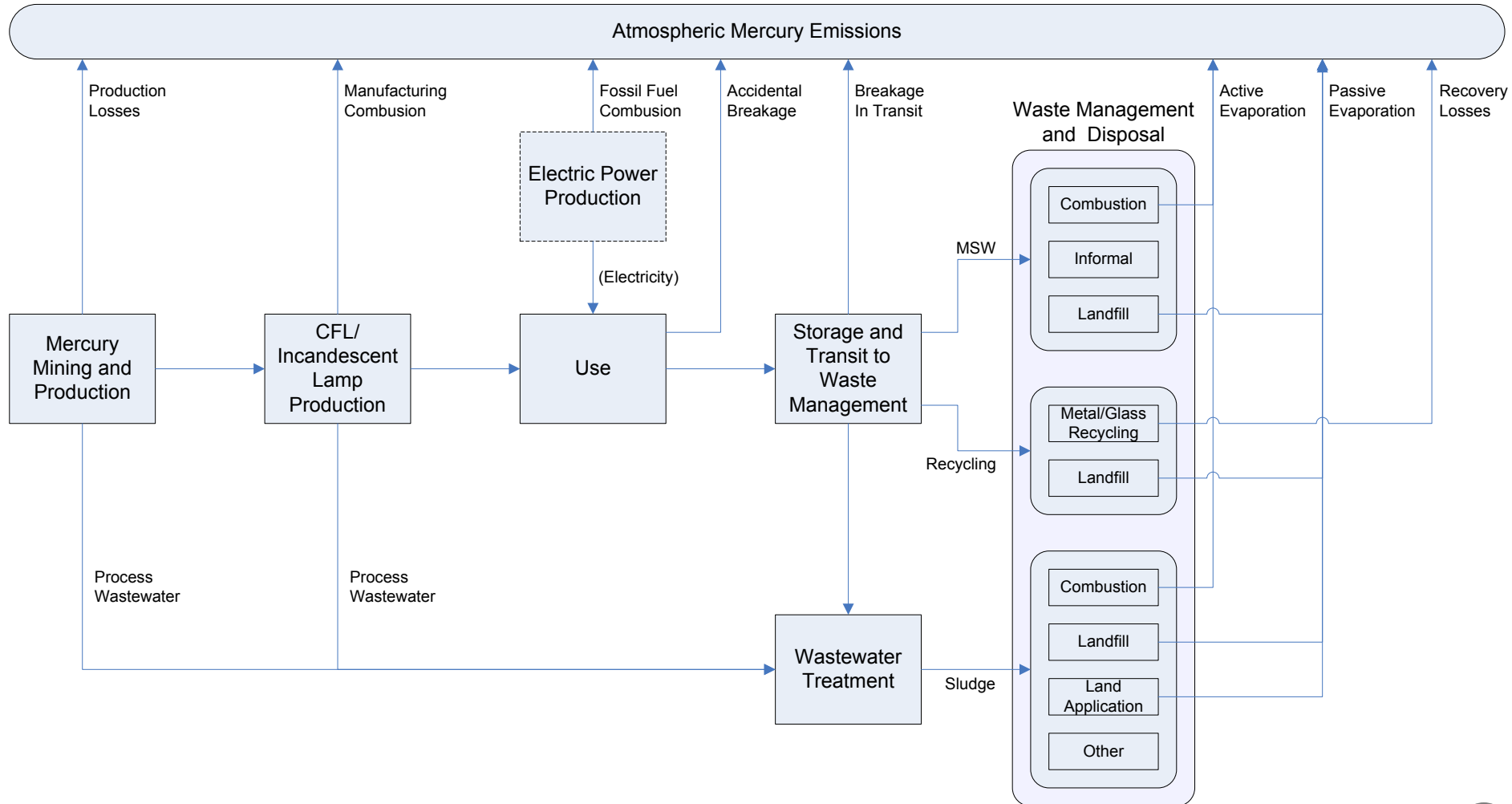

Indirect Mercury Emissions

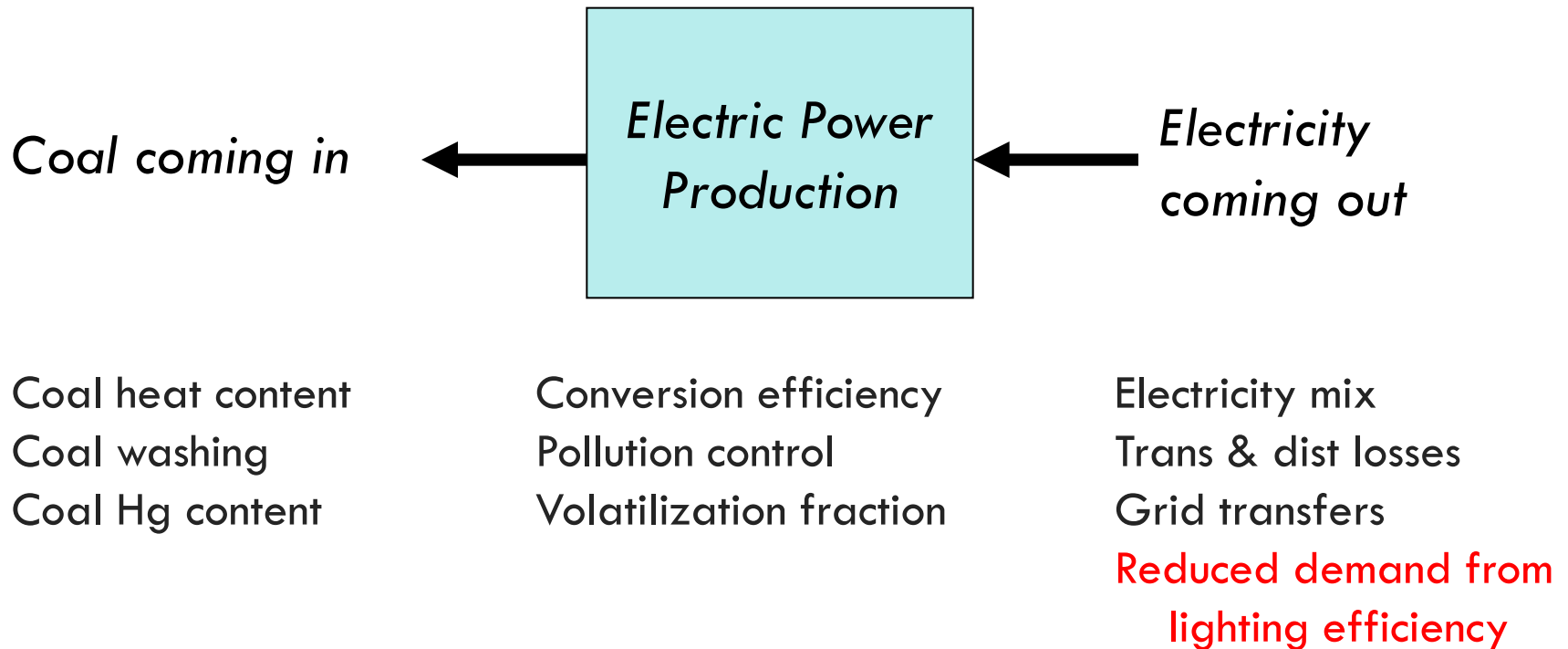



US Results

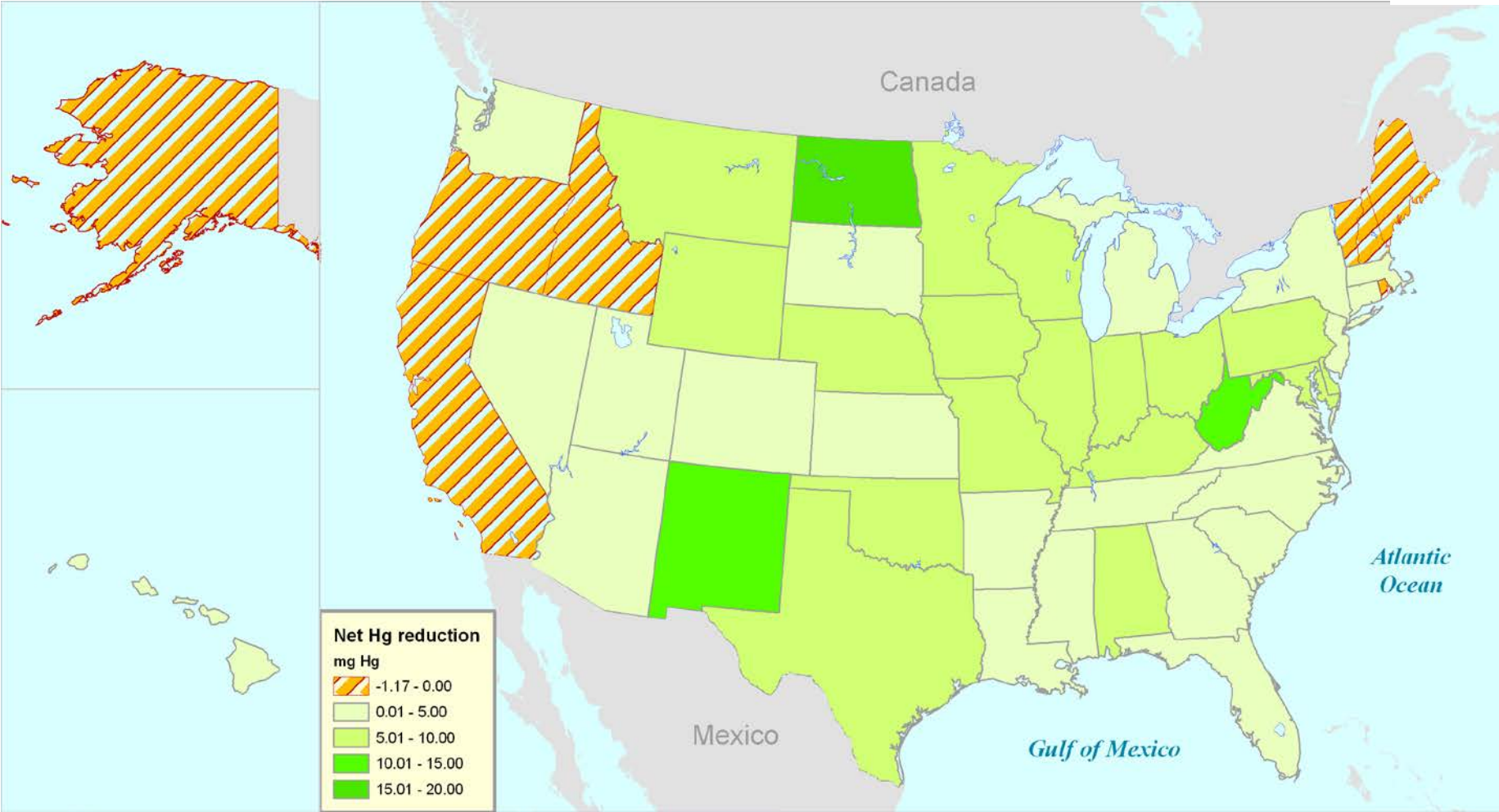

Eckelman, et al. (2008). *Environ. Sci. Technol.* 42, 8564-8570

Ex2- Carbon Nanotube Life Cycle

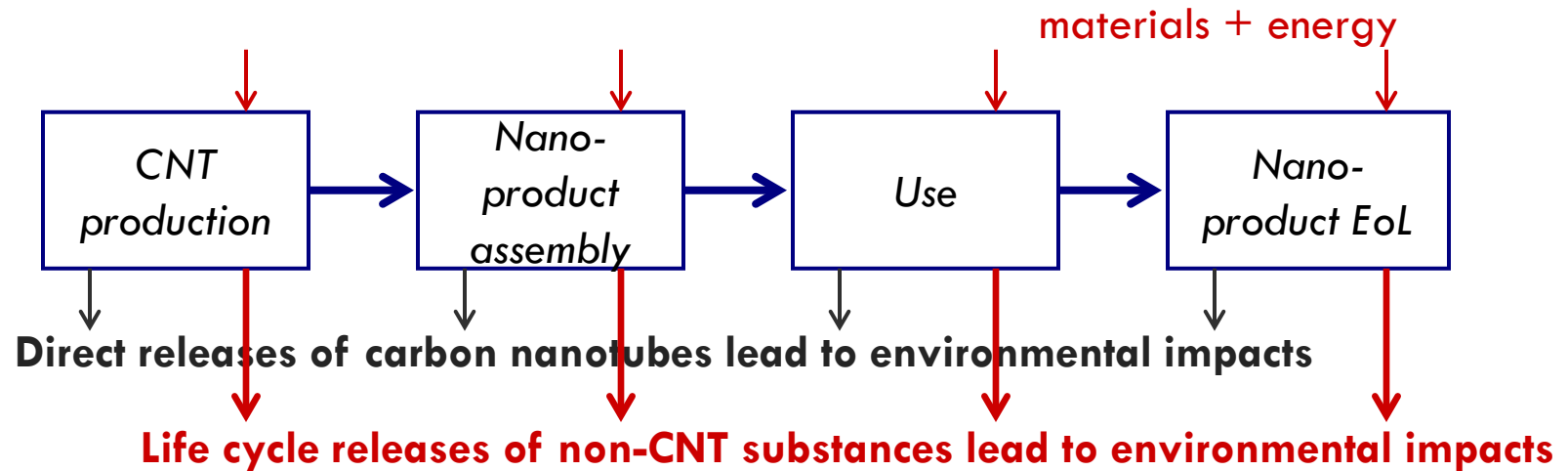

- Adapt consensus USEtox impact assessment model for SWNTs to include colloidal processes
- Only consider freshwater ecotoxicity

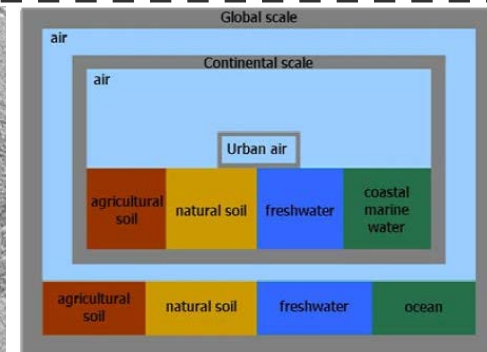
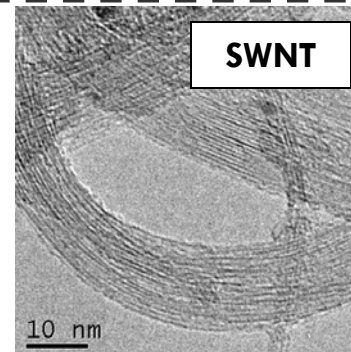

Differential CNT Toxicity

- Metallic or semiconducting depending on chirality and number – this also helps determine toxicity
- Large variation among CNT types in parameters that affect fate, transport, and toxicity

• STRIP OF A GRAPHENE SHEET ROLLED INTO A TUBE

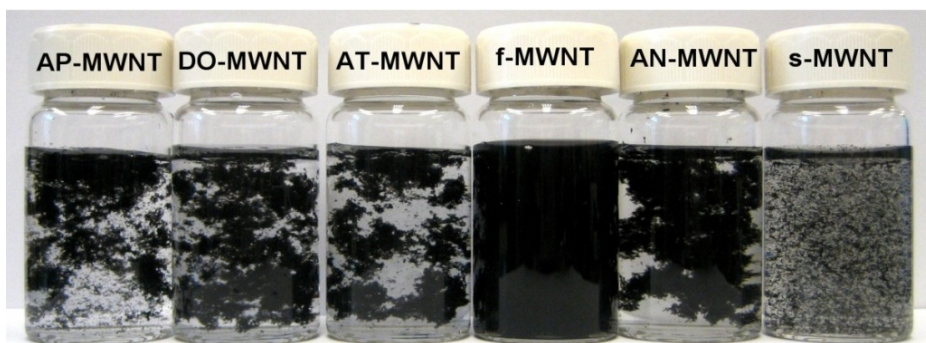
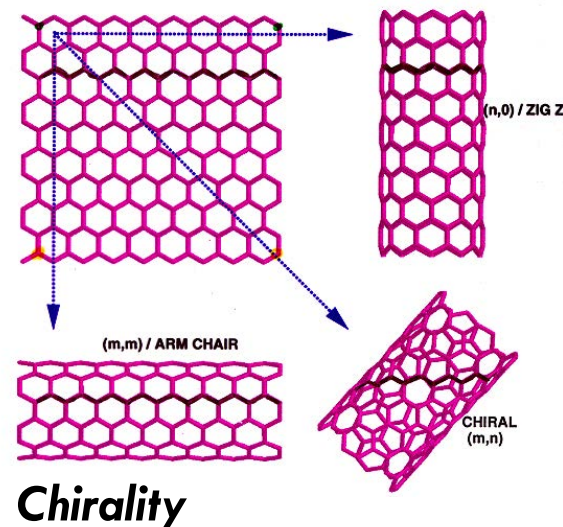

Purification and treatment

Aspect ratio

Residual metal content

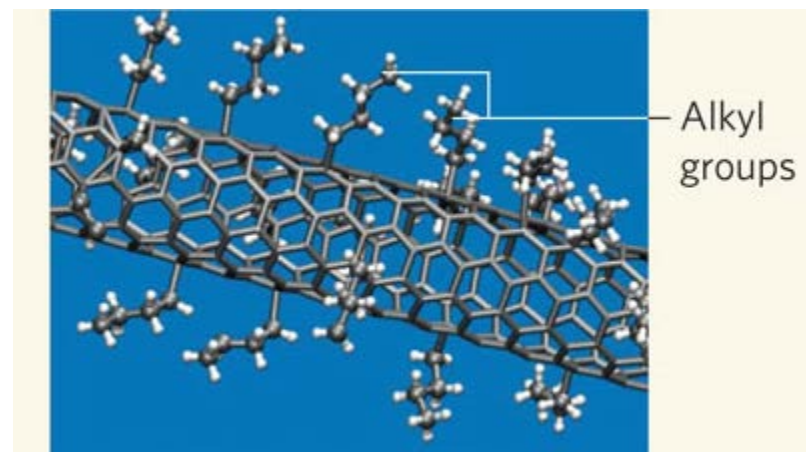

Functionalization

CNT Releases

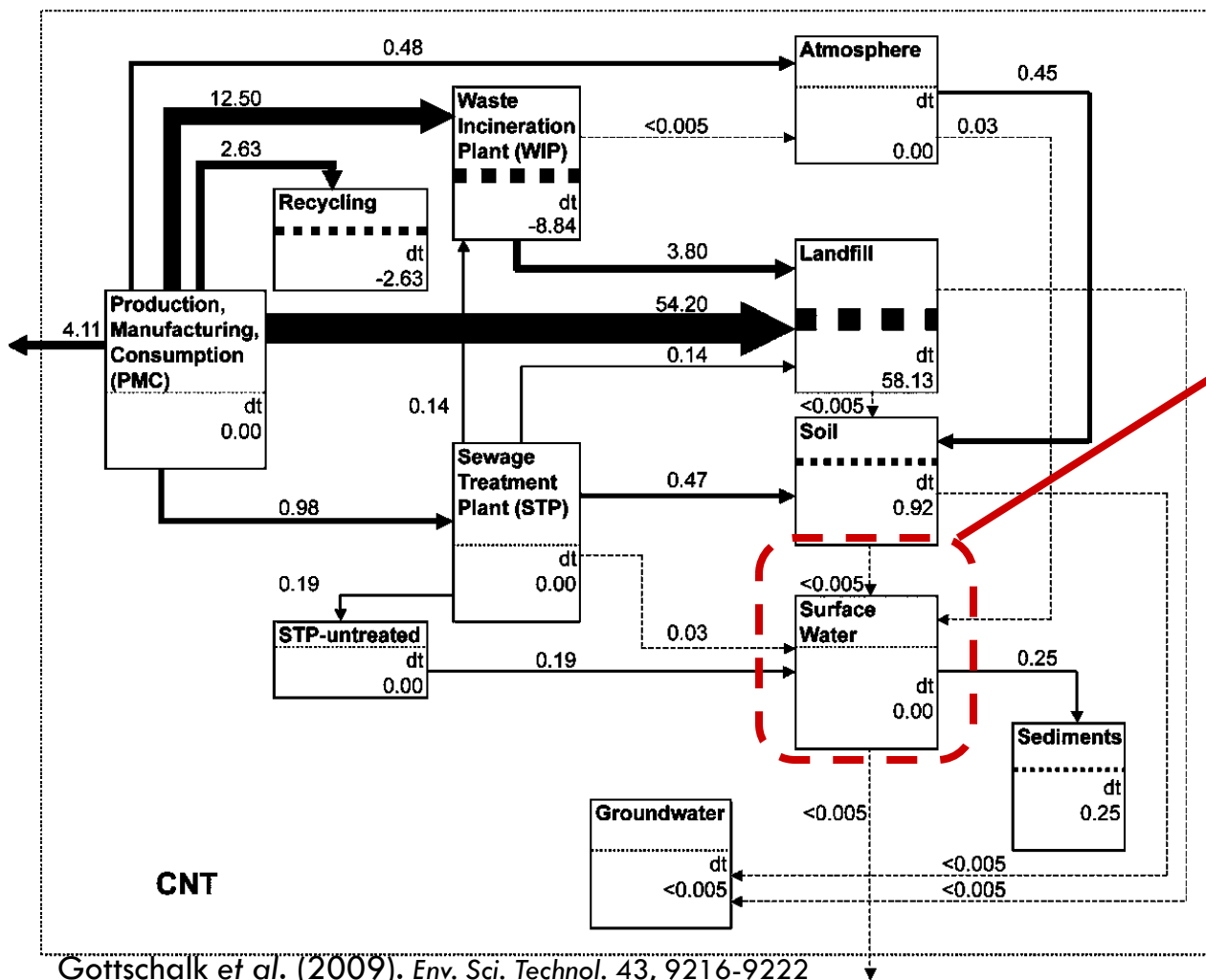

Worst Case Scenario

100% release;
All CNTs stable in
water column

Realistic Scenario

Modeled concentrations
based on fate and
transport parameter
estimates

CNT Ecotoxicity Production vs Releases

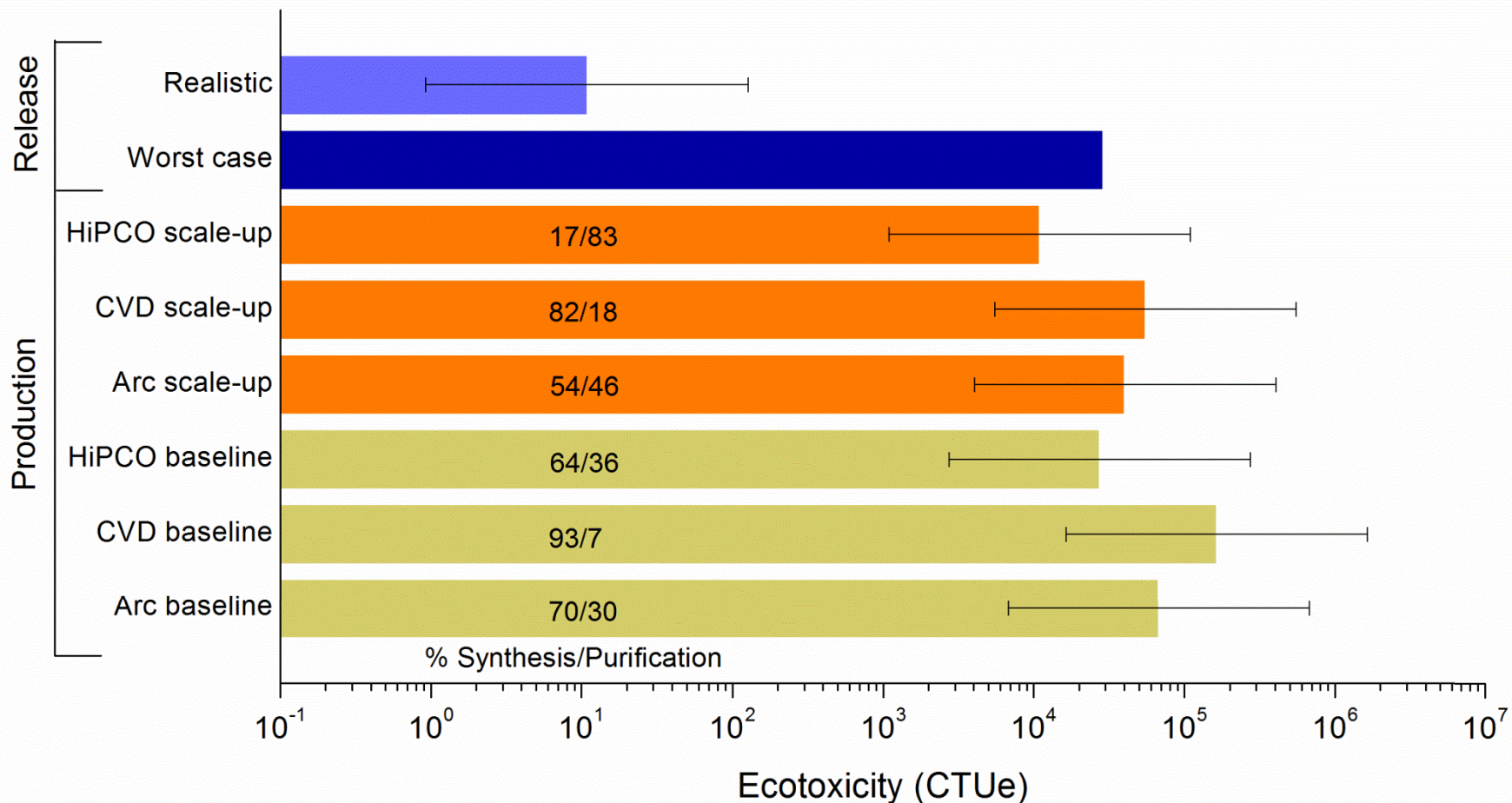

Eckelman, et al. (2012). *Environ. Sci. Technol.* 46, 2902-2910

Bits

OCTOBER 28, 2012, 2:00 PM | 34 Comments

I.B.M. Reports Nanotube Chip Breakthrough

By JOHN MARKOFF

 FACEBOOK

 TWITTER

 GOOGLE+

 E-MAIL

 SHARE

 PRINT

SAN FRANCISCO — [I.B.M.](#) scientists are reporting progress in a chip-making technology that is likely to ensure that the basic digital switch at the heart of modern microchips will continue to shrink for more than a decade.

The advance, first described in the journal *Nature Nanotechnology* on Sunday, is based on carbon nanotubes — exotic molecules that have long held out promise as an alternative to silicon from which to create the tiny logic gates now used by the billions to create microprocessors and memory chips.

The I.B.M. scientists at the T.J. Watson Research Center in Yorktown Heights, N.Y., have been able to pattern an array of carbon nanotubes on the surface of a silicon wafer and use them to build hybrid chips with more than 10,000 working transistors.

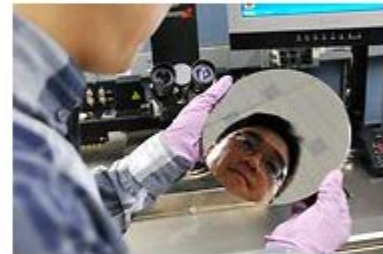

I.B.M. Research

The face of an I.B.M. research scientist, Hongsik Park, is reflected in a wafer used to make microprocessors.

Life Cycle of Nano-enabled Products

Should a new GE principle be no nano?

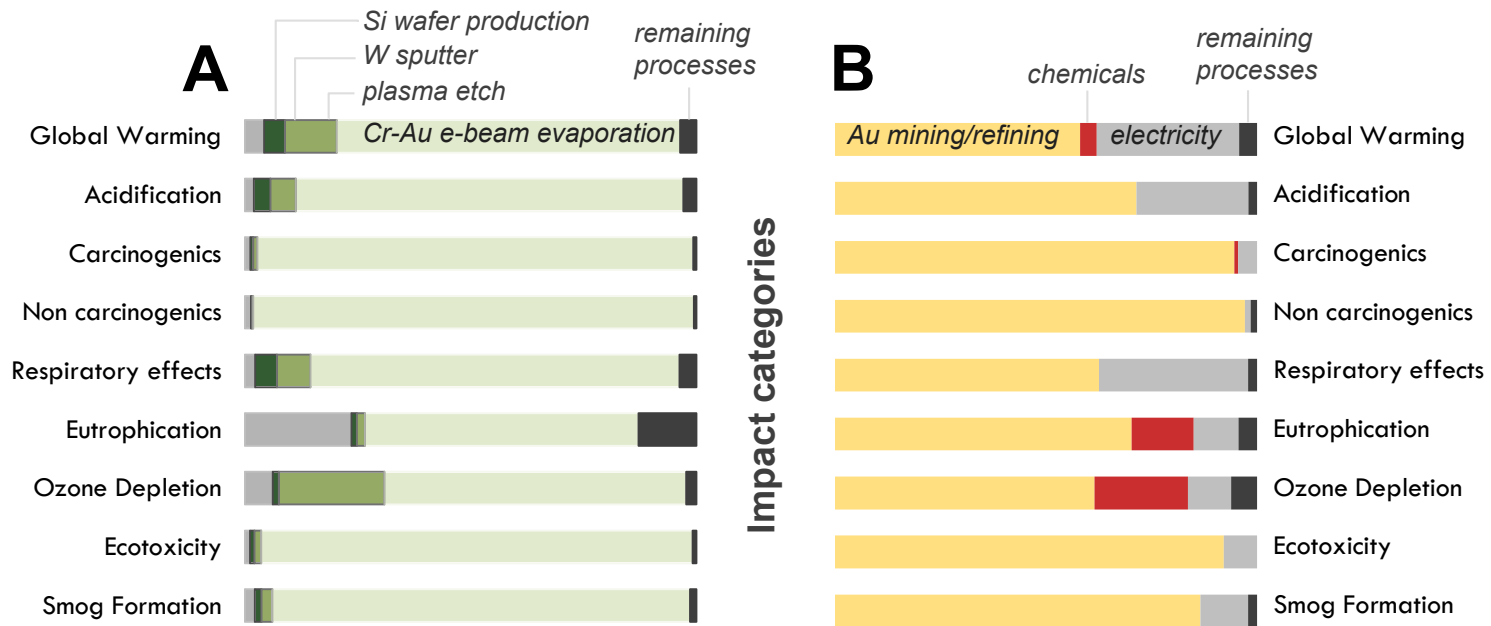

CNT synthesis is insignificant: <math><0.0000000000000001\%</math> of impacts

Integration of Green Chem/Eng + LCA

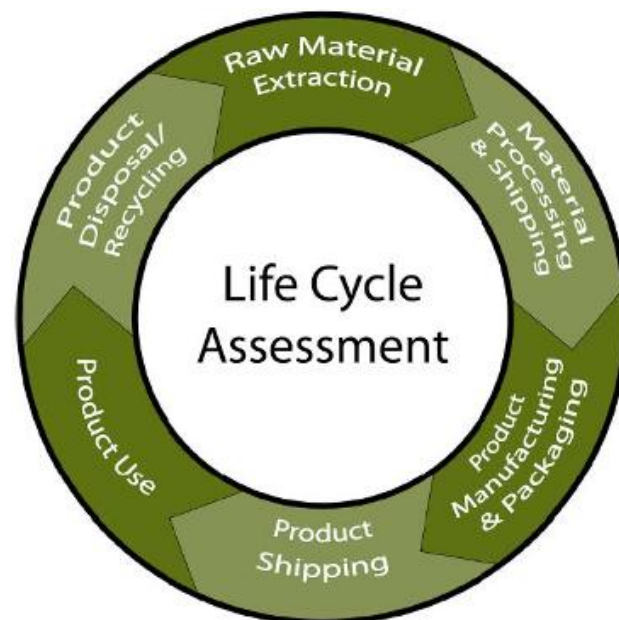

We're getting closer...

Green Chemistry Limitations

- GC Principles guard against use of toxic inputs, but the field does not have a consensus quantitative method for evaluating upstream inherent risk

- *iSustain* metrics for green chemistry principles

$$I = \frac{\sum_i (\text{MatImpact}_i)(\text{wt}\% \text{RawMat}_i)(100 - \text{Rec}\%_i)}{\sum_i (\text{wt}\% \text{RawMat}_i)(100 - \text{Rec}\%_i)}$$

scaled 1-100 on safety, health effects,
environment, regulatory status

- Only considers 'first tier' inputs, doesn't consider multiple intermediate steps and complexities

Green Chemistry and LCA

- *Life cycle assessment and green chemistry: the yin and yang of industrial ecology*
 - Anastas and Lankey
- *Life-Cycle Approaches for Assessing Green Chemistry Technologies*
 - Lankey and Anastas
- LCA identifies hotspots and GC used to inform design...

Life Cycle Assessment Limitations

characterization factors have units of
impact/kg emitted...

zero emissions means zero impacts

Ex: Polycarbonate via Phosgene Process

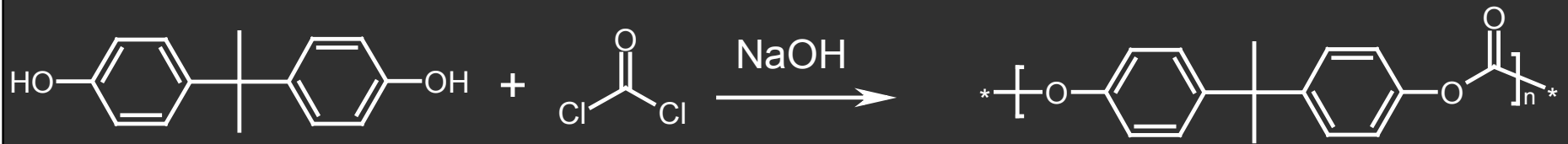

- ❑ Polycarbonate is contaminated with Cl
- ❑ Requires stoichiometric quantities of phosgene
- ❑ Phosgene is highly toxic and corrosive

Alter Computational Structure of LCA

To calculate the LCI of a product system generating a given reference flow, we first calculate the **activity vector**, which represents all outputs of the product system, including all **intermediate flows**

$$\vec{q} = \mathbf{A} \times \vec{\gamma} \Rightarrow \vec{\gamma} = \mathbf{A}^{-1} \times \vec{q}$$

and multiply the vector of activity levels with the matrix of elementary flows

$$\vec{e} = \mathbf{B} \times \vec{\gamma}$$

Impacts are calculated with the inventory vector and characterization factors:

$$\begin{pmatrix} c_{11} & c_{12} & c_{13} & c_{14} \\ c_{21} & c_{22} & c_{23} & c_{24} \\ c_{31} & c_{32} & c_{33} & c_{34} \end{pmatrix} \begin{pmatrix} e_1 \\ e_2 \\ e_3 \\ e_4 \end{pmatrix} = \begin{pmatrix} i_1 = \sum_{m=1}^4 c_{1m} \cdot e_m \\ i_2 = \sum_{m=1}^4 c_{2m} \cdot e_m \\ i_3 = \sum_{m=1}^4 c_{3m} \cdot e_m \end{pmatrix}$$

New LCA Metrics Using GC Concepts

Now calculate impacts based on *use* of all intermediate flows, rather than emissions

$$i^* = \sum_k c_k \cdot \gamma_k$$

This represents **life cycle inherent hazard** or toxicity
NOT based on projected emissions

Conclusions

- Life cycle modeling is a useful complement to Green Engineering design principles
- Indirect impacts or benefits may outweigh direct effects, so be careful for unintended trade-offs
- New tools and metrics are being introduced regularly to support Green Engineering practices

GC3 Webinar on Green Engineering

Matthew Eckelman, PhD
Assistant Professor
Civil & Environmental Engineering
Northeastern University
m.eckelman@neu.edu

Thanks!



GC3 Webinar on Green Engineering

Julie M. Schoenung, Ph.D.
Professor and Vice Chair
Department of Chemical Engineering & Materials Science
University of California, Davis
July 29, 2014

jmschoenung@ucdavis.edu

Green Engineering Case Studies: Methods and Applications

- Economic Assessment
 - Materials Recovery Facility for Computer Displays (CRTs)
 - Cell Phone Disassembly
- Toxicity Potential and Chemical Hazard Assessment
 - Utility Meter Products
 - Thin Film Photovoltaics (CIGS)
- Hazardous Waste, Resource Depletion and Toxicity Potentials
 - Light Emitting Diodes (LEDs)
 - Artificial Lighting (LEDs, CFLs, Incandescent)



Green Engineering Case Studies: Methods and Applications

– Economic Assessment

- Materials Recovery Facility for Computer Displays (CRTs)
- Cell Phone Disassembly

– Toxicity Potential and Chemical Hazard Assessment

- Utility Meter Products
- Thin Film Photovoltaics (CIGS)

– Hazardous Waste, Resource Depletion and Toxicity Potentials

- Light Emitting Diodes (LEDs)
- Artificial Lighting (LEDs, CFLs, Incandescent)





Materials flow for end-of-life electronics

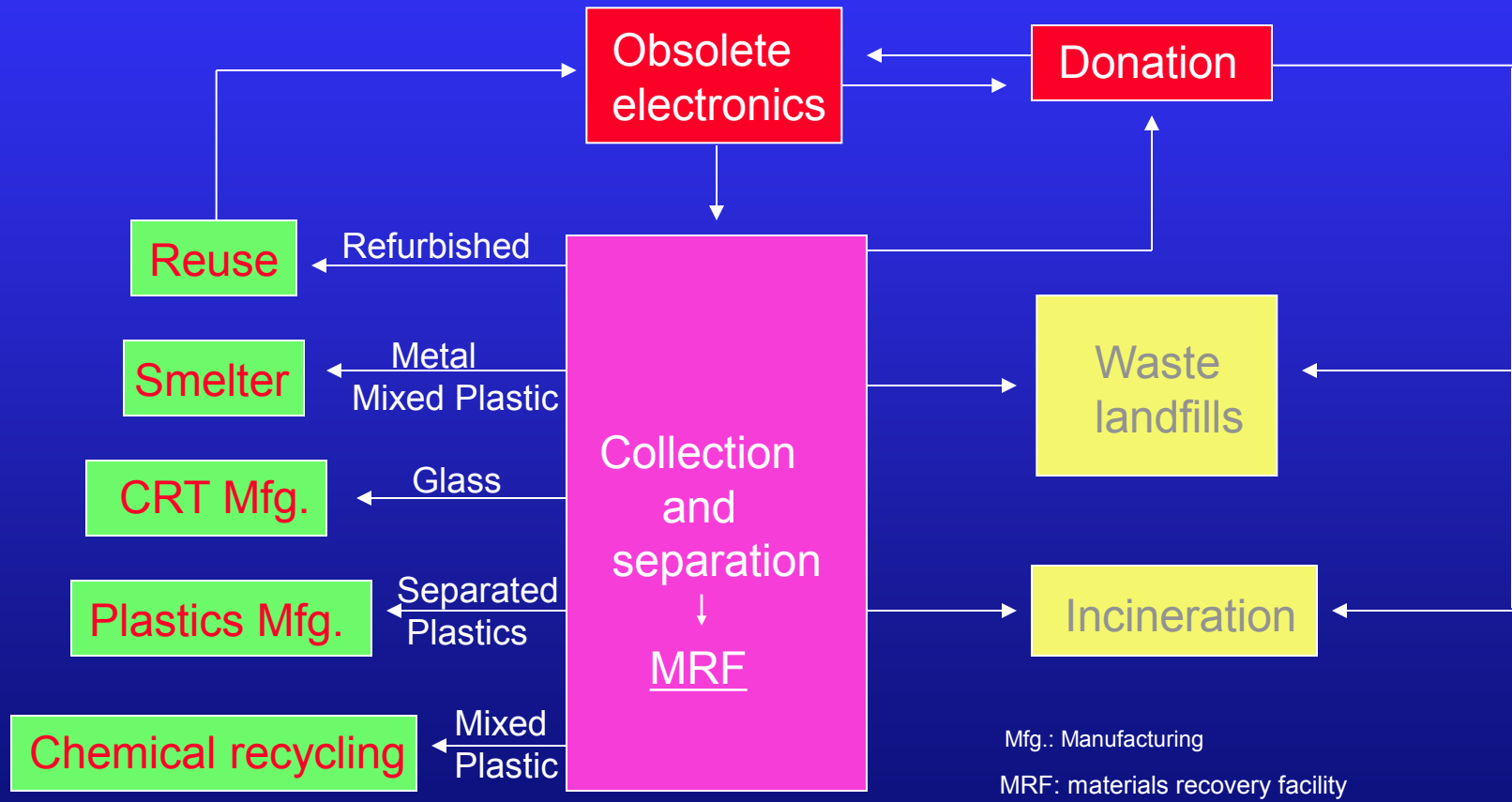



Cathode Ray Tube (CRT) recycling

Glass-to-Glass recycling

- Closed loop recycling
- Conventional process
 - Separate case and metal part
 - Depressurize the tube, grind to cullet
 - Mixed output
- Saw cutting process
 - Cut with saw
 - Intact panel and funnel glass
 - Separate panel and funnel glass

Glass-to-Lead (Pb) recycling

- Open loop recycling
- Pb in the CRTs
- Crush and remove foreign materials
- Pb smelter



CRTs after depressurized
Exporting harm, 2002



Saw cut CRT : funnel, panel.
Deer2,2003

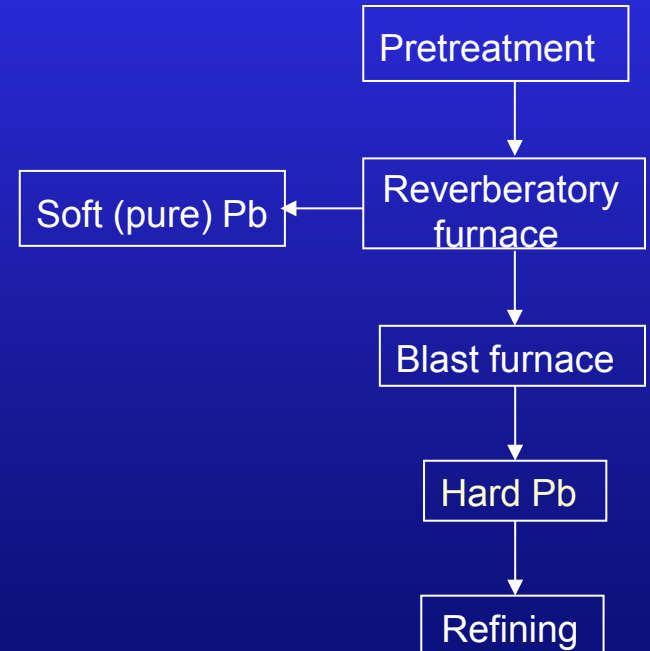



Secondary copper (Cu) recycling

- **Blast Furnace**
 - Electronic scrap: 5 ~ 40 % Cu
 - Reduction; $Fe + Cu_2O \rightarrow FeO + 2Cu$
 - Black Copper: 70 ~ 85%Cu
- **Converter**
 - Oxidation : $4Cu + O_2 \rightarrow 2Cu_2O$
 - Blister Copper : ~95% Cu, oxide form.
- **Anode Furnace**
 - Reduce Cu (**reductant: plastics**, wood)
 - Cu cast into Anode : ~ 98.5% Cu
- **Refining Electrolysis**
 - Dissolved in H_2SO_4 electrolyte
 - Pure Cu deposited on cathode : 99.99%
 - Precious metals recovered as anode slimes

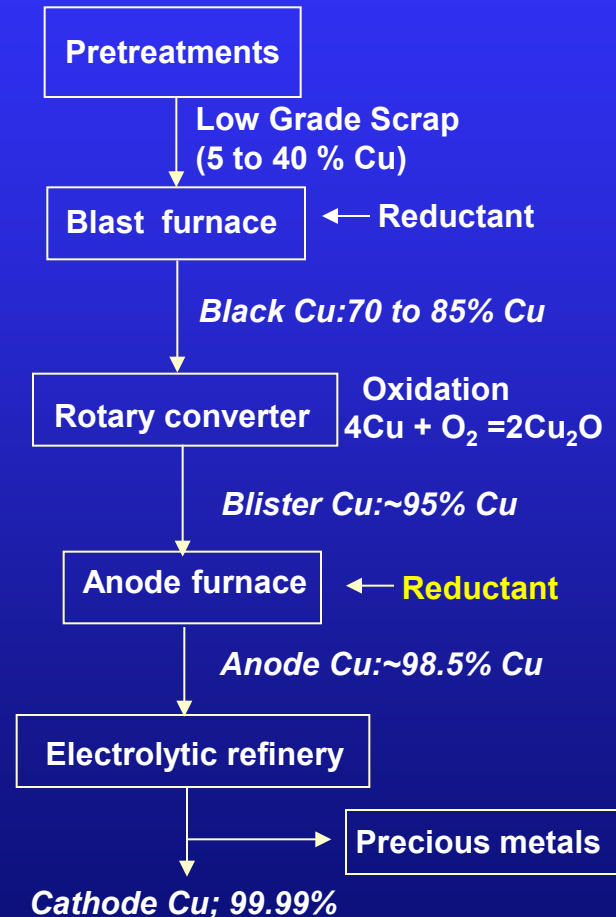



Precious metals recovery

- Silver, gold, platinum, palladium
- By-products of copper smelter
- Anode slime from copper electrolysis process.

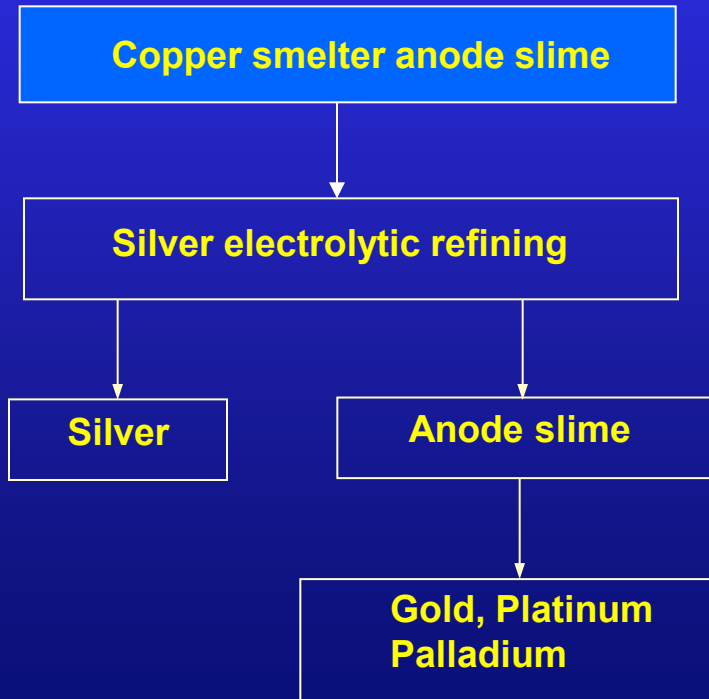



Flow of cost and revenue in a MRF

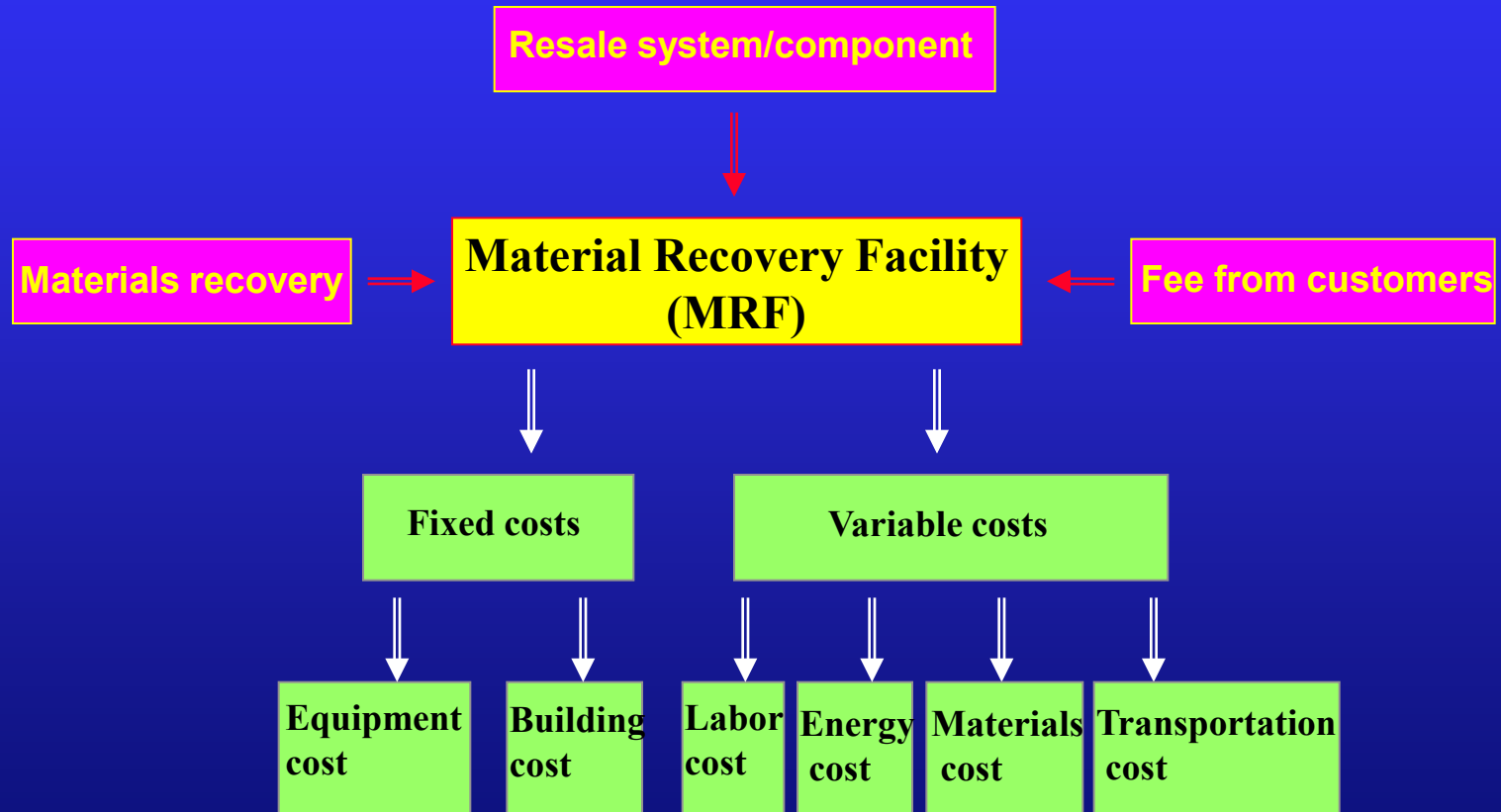



Cost analysis (1)

Annual operating cost for an e-waste MRF.

Cost element

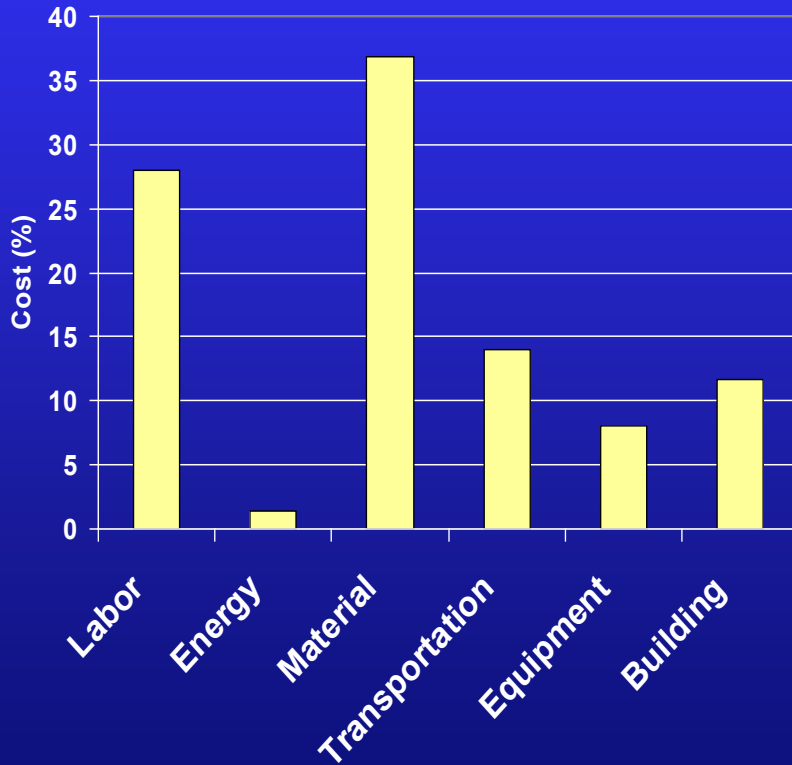

Unit operation

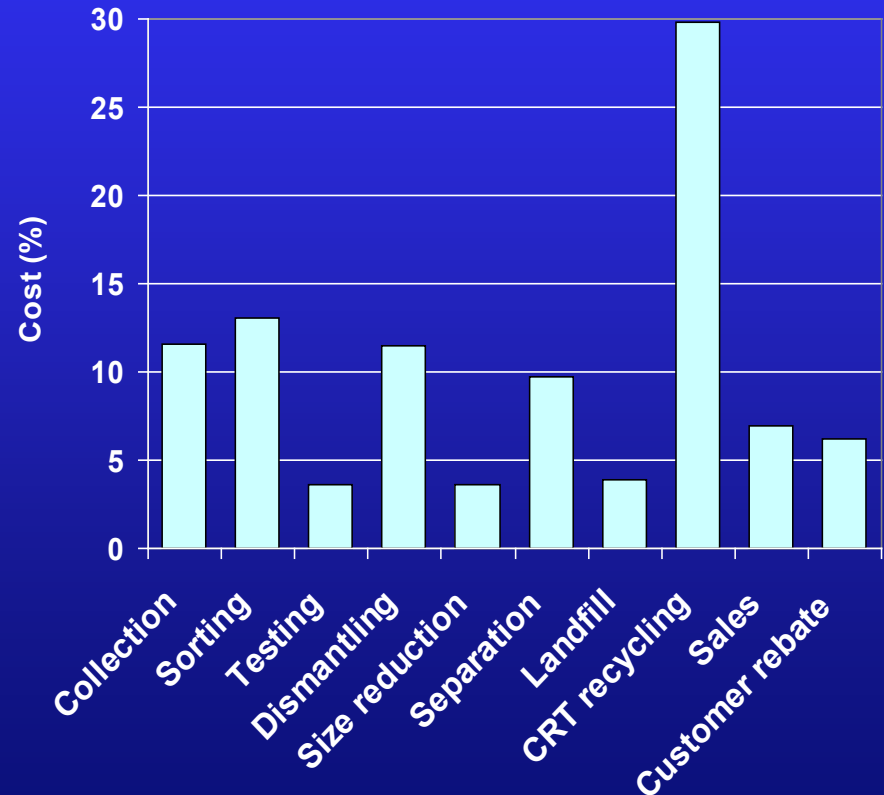

CRT: 75 wt%, CPU: 25 wt%. Treatment amount: 2,500 ton/year.



Revenue analysis (1)

Distribution of revenue by revenue source

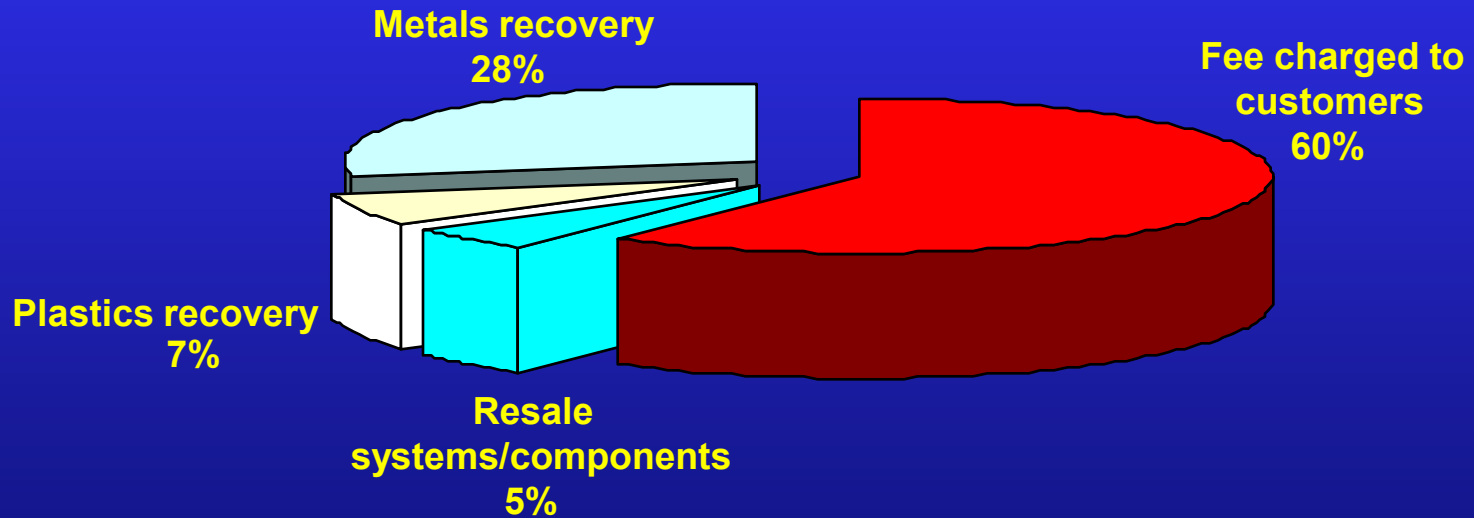

CRT: 75 wt%, CPU: 25 wt%, Total treatment: 2,500 ton/year.

Green Engineering Case Studies: Methods and Applications

– Economic Assessment

- Materials Recovery Facility for Computer Displays (CRTs)
- Cell Phone Disassembly

– Toxicity Potential and Chemical Hazard Assessment

- Utility Meter Products
- Thin Film Photovoltaics (CIGS)

– Hazardous Waste, Resource Depletion and Toxicity Potentials

- Light Emitting Diodes (LEDs)
- Artificial Lighting (LEDs, CFLs, Incandescent)



Characteristics of the product system for a cell phone

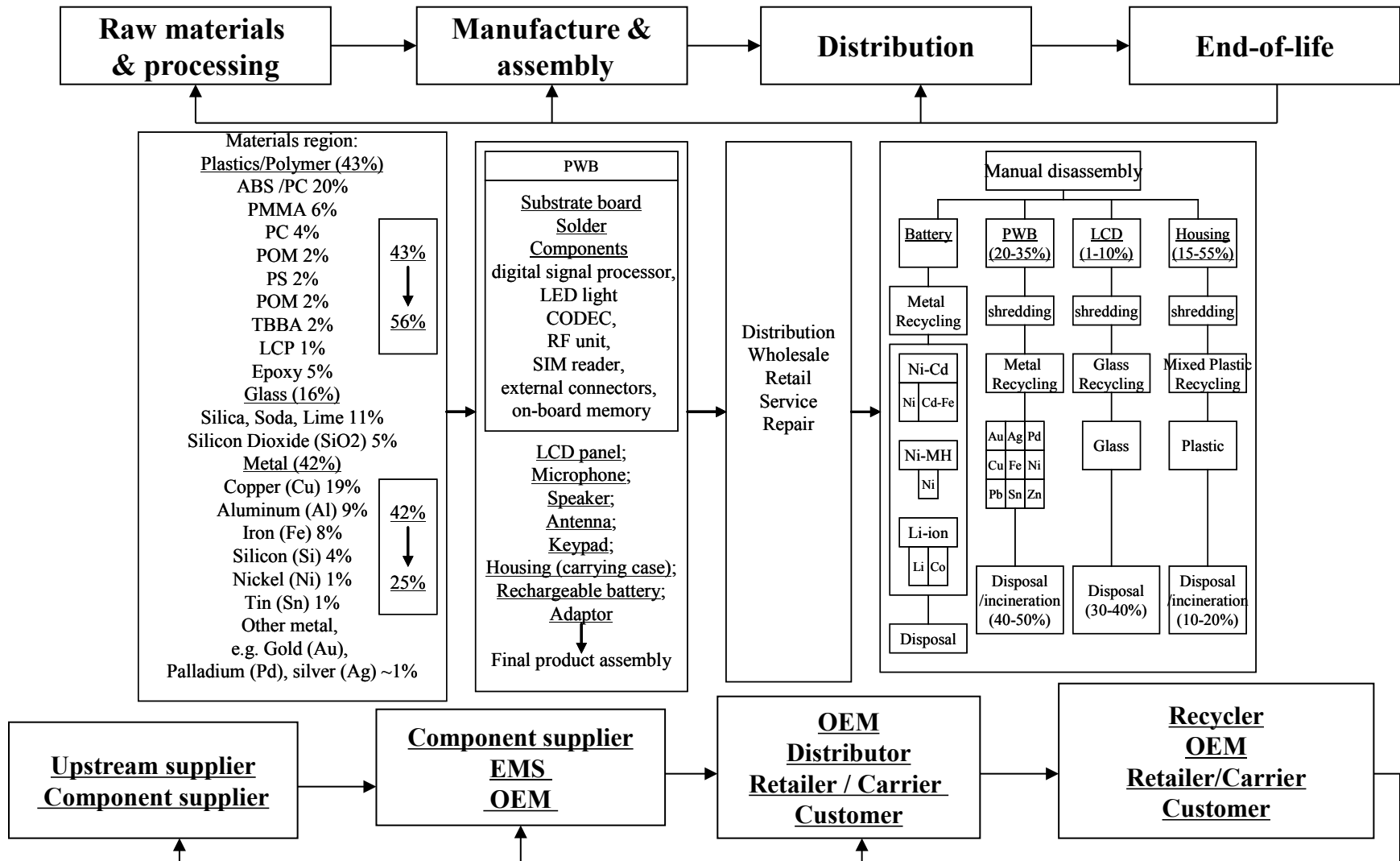

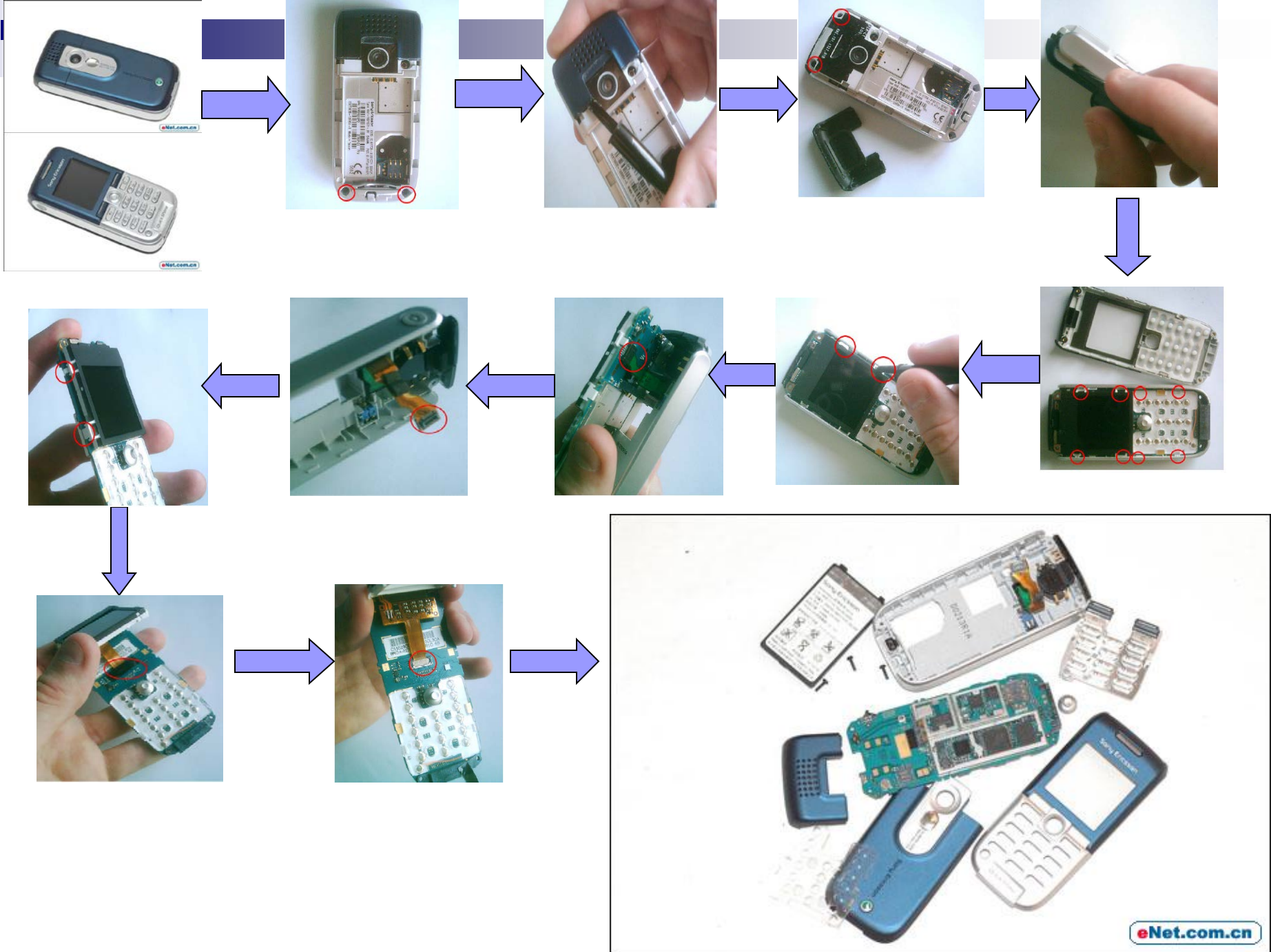

Hierarchical “bill of materials” based structure of a cellular phone

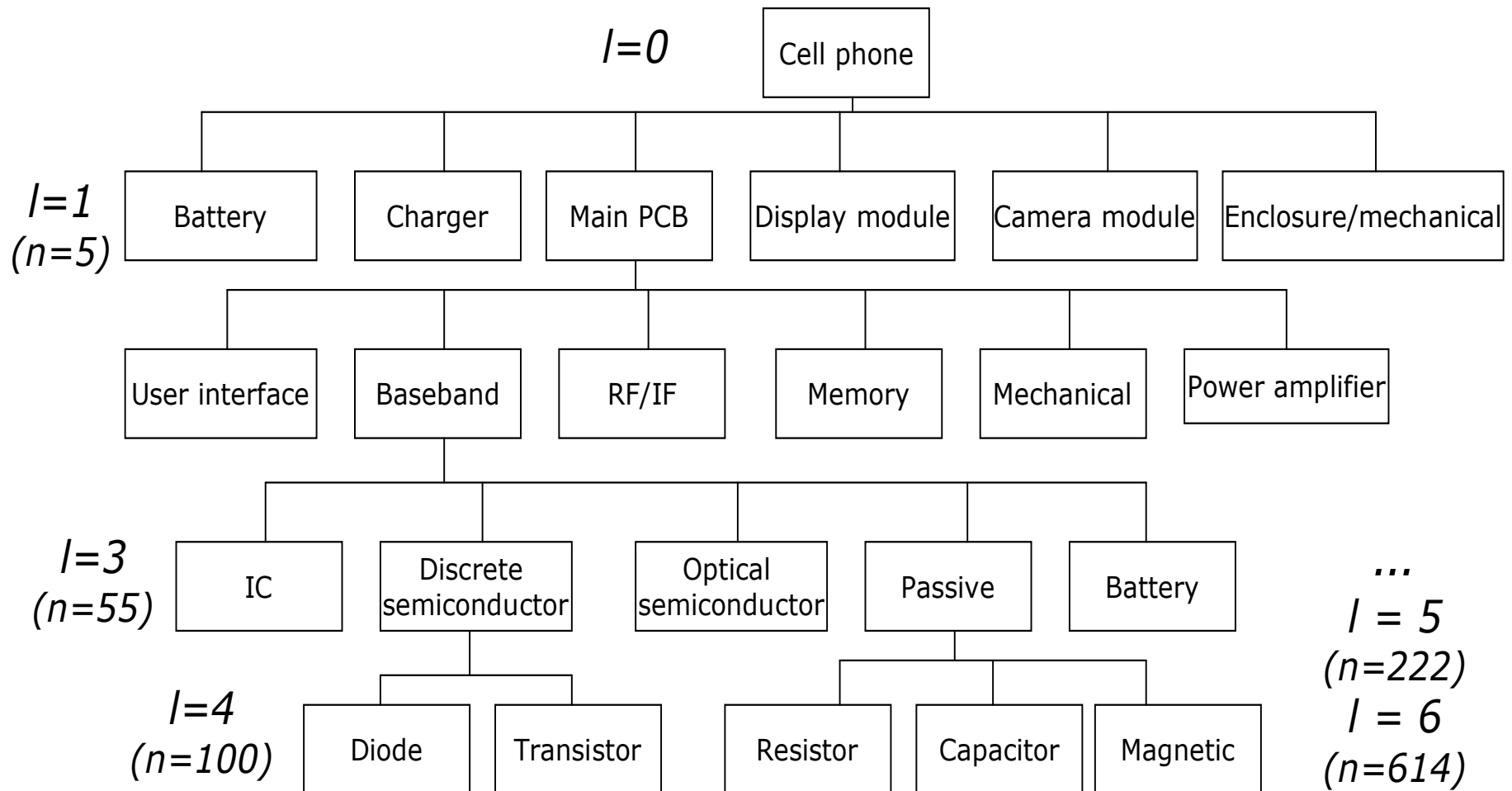

Disassembly revenue

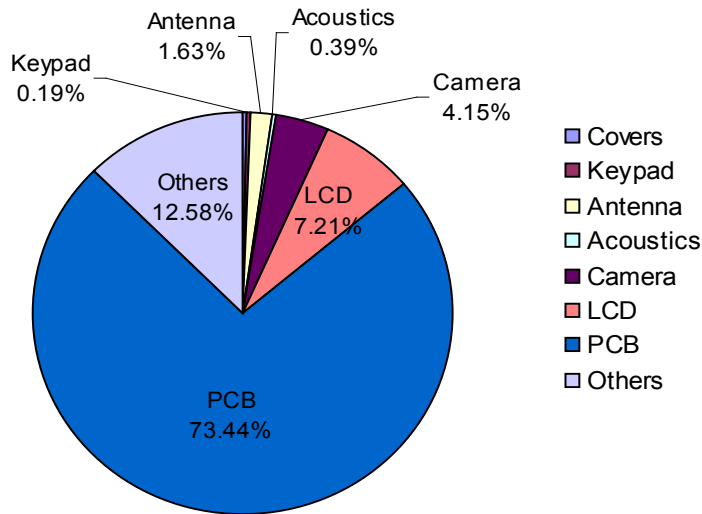

Disassembly revenue
(quality scenario: malfunction)

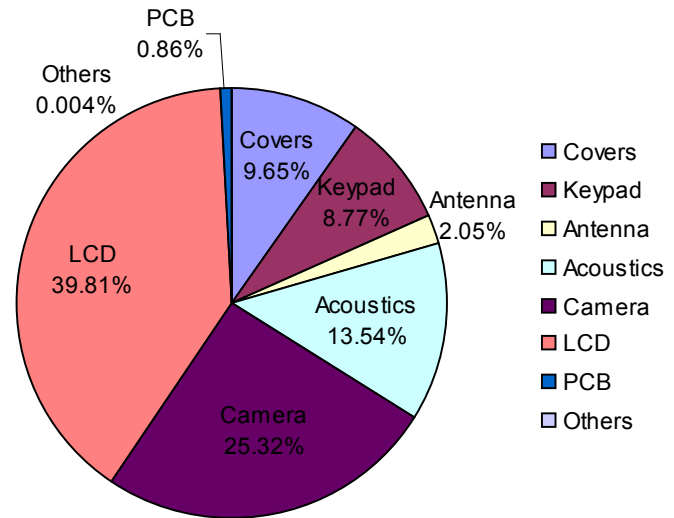

Disassembly revenue
(quality scenario = good condition)

Direct materials cost

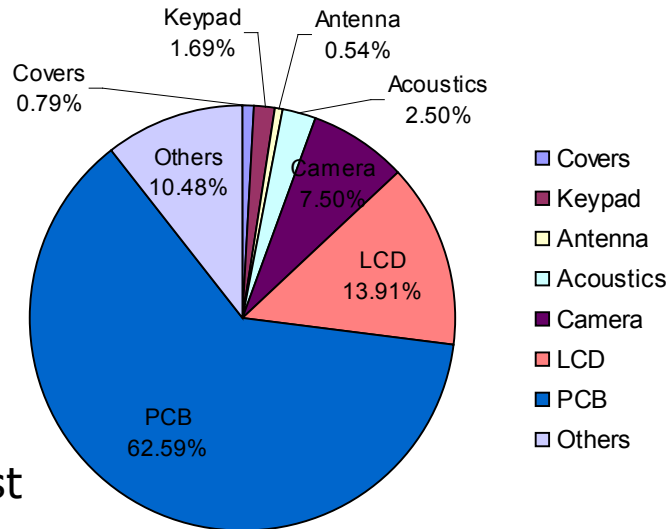

Green Engineering Case Studies: Methods and Applications

- Economic Assessment
 - Materials Recovery Facility for Computer Displays (CRTs)
 - Cell Phone Disassembly
- Toxicity Potential and Chemical Hazard Assessment
 - Utility Meter Products
 - Thin Film Photovoltaics (CIGS)
- Hazardous Waste, Resource Depletion and Toxicity Potentials
 - Light Emitting Diodes (LEDs)
 - Artificial Lighting (LEDs, CFLs, Incandescent)



Reducing toxicity potential in RIO Tronics electronic utility meter products

- (a) PulsePoint - for domestic gas meters
- (b) RegistRead – for dial indexes on both gas and electric meters
- (c) RotaRead - for rotary gas meters
- (d) Remote Consumption Display (RCD) – display unit connectable to other meter sensors

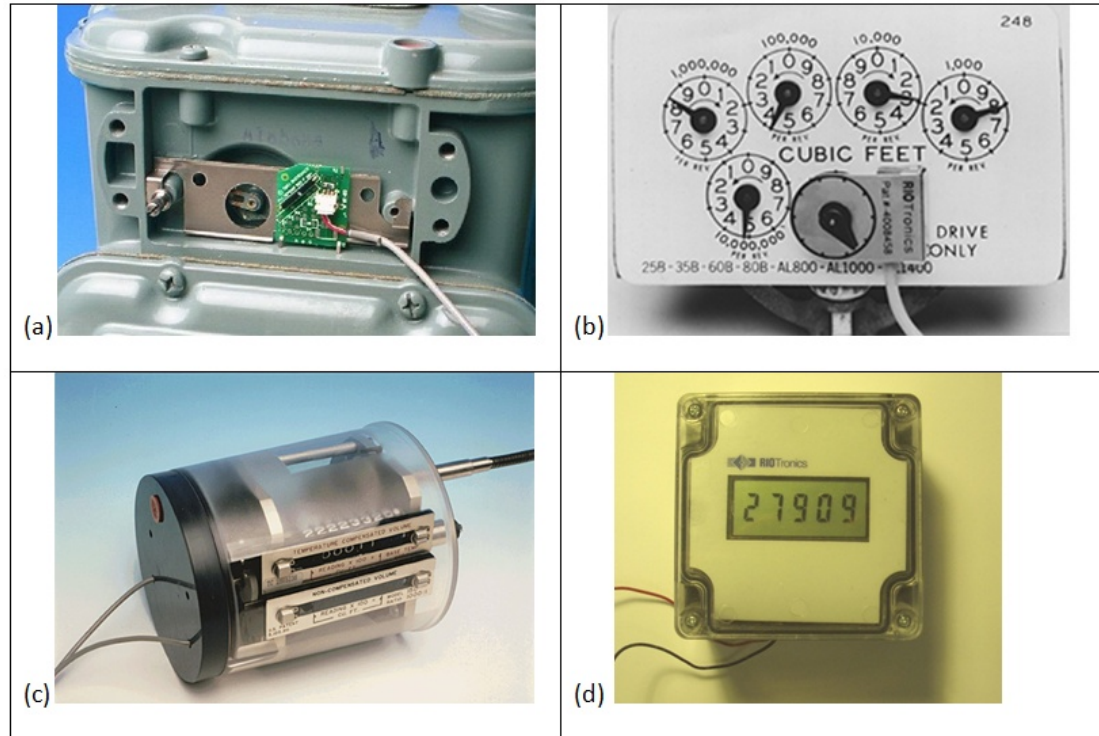

Product bill-of-materials

- Bill of materials information provided by RIO Tronics
- Component compositions are quantified based on information provided by component manufacturers/suppliers and also estimated through dimensional specifications (e.g., printed wiring board components).
- Composition uncertainty is introduced due to reliability of data

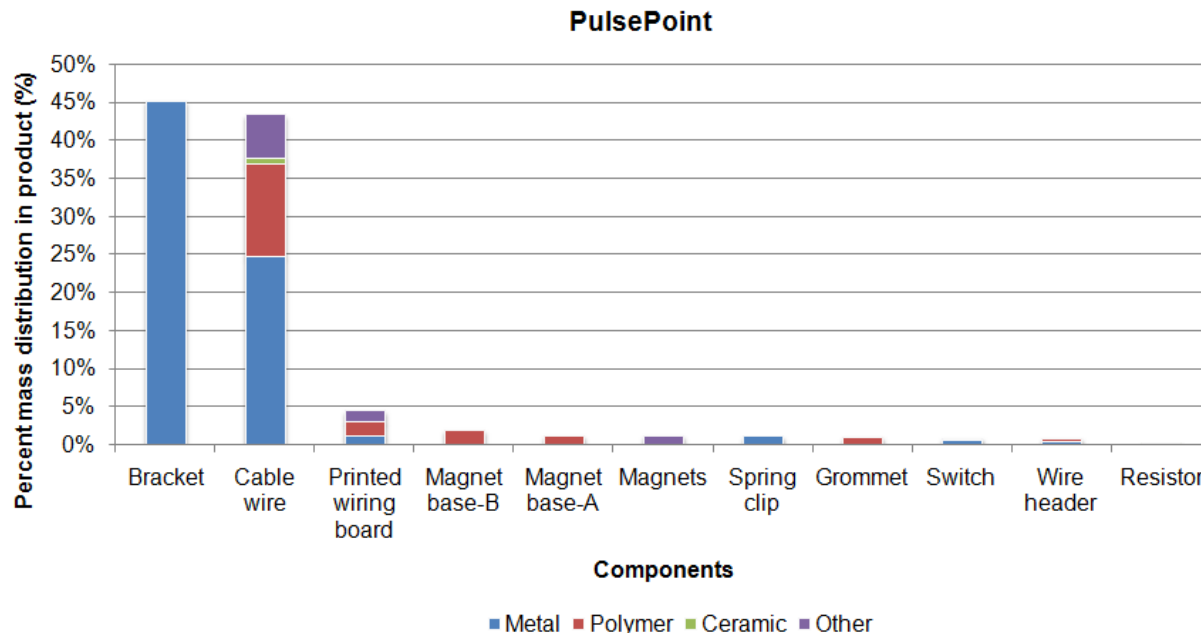

Fraunhofer IZM Toxic Potential Indicator (TPI)

Takes into account three main toxicity inputs based on European Union (EU) regulations:

- 1) Occupational exposure limits based on maximum workplace concentration (MAK) or EU carcinogenic classification;
- 2) Water hazard classification (WGK); and
- 3) Risk phrases (R-phrases)

Outputs a TPI score for materials from zero to 100.

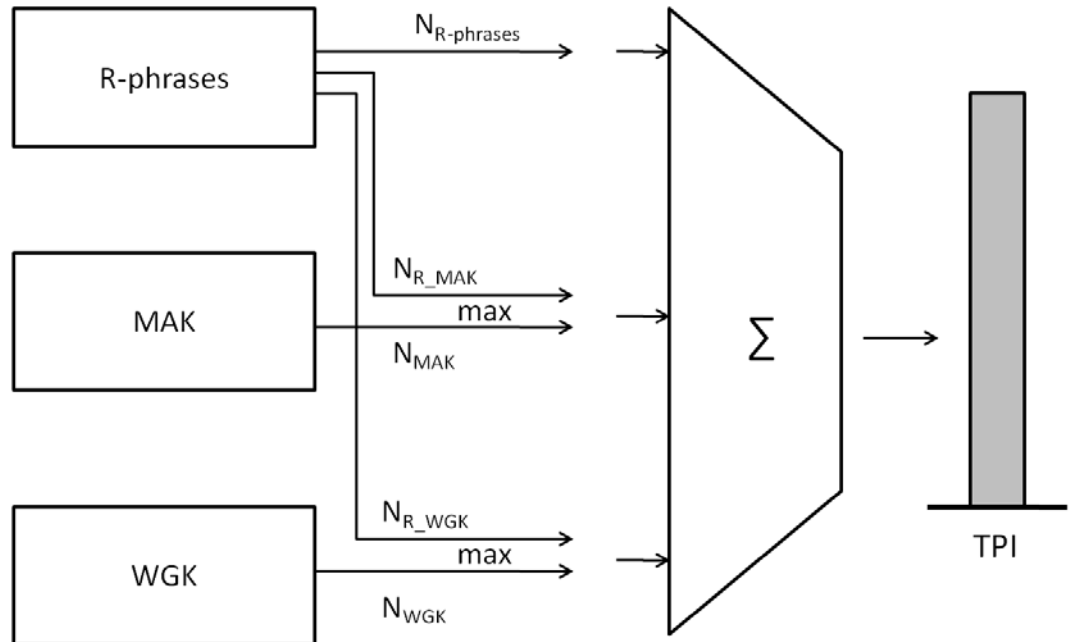

Two component TPI scoring methods

- 1) Sum-weighted Component TPI method – weighs TPI scores by mass of materials in components

$$\text{TPI_sum}_k = \sum \text{mass}_{j,k} * \text{TPI}_{j,k}$$

- 2) Max Component TPI method – assigns max TPI score to component based on highest impact material

$$\text{TPI_max}_k = \max(\text{TPI}_{\text{all_materials},k})$$

where j represents material and k represents component.

Summary Results for Both Component TPI Scoring Methods (e.g., PulsePoint)

PulsePoint Component Rank	Sum-weighted method (baseline)	Sum-weighted method (sensitivity analysis)	Max method (baseline)	Max method (sensitivity analysis)
1	Bracket	Bracket	Grommet	Grommet
2	Cable wire	Cable wire	Bracket	Bracket
3	Grommet	Magnets	Spring clip	Spring clip
4	Magnet base-B	Grommet	Printed wiring board	Printed wiring board
5	Spring clip	Magnet base-B	Resistor	Resistor

Green Engineering Case Studies: Methods and Applications

- Economic Assessment
 - Materials Recovery Facility for Computer Displays (CRTs)
 - Cell Phone Disassembly
- Toxicity Potential and Chemical Hazard Assessment
 - Utility Meter Products
 - Thin Film Photovoltaics (CIGS)
- Hazardous Waste, Resource Depletion and Toxicity Potentials
 - Light Emitting Diodes (LEDs)
 - Artificial Lighting (LEDs, CFLs, Incandescent)





Overview of CIGS Technology

CIGS is one of the most promising thin-film PV technologies

CIGS = CuInGaS/Se

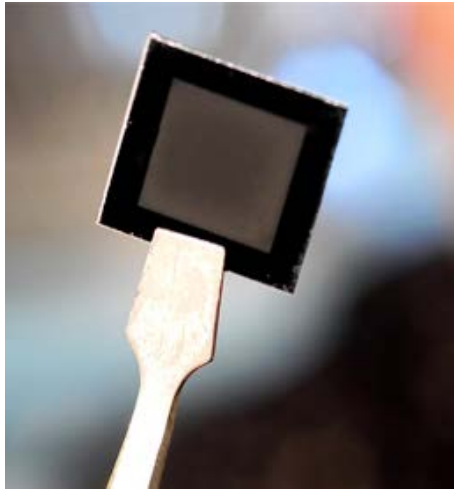

Thin Film

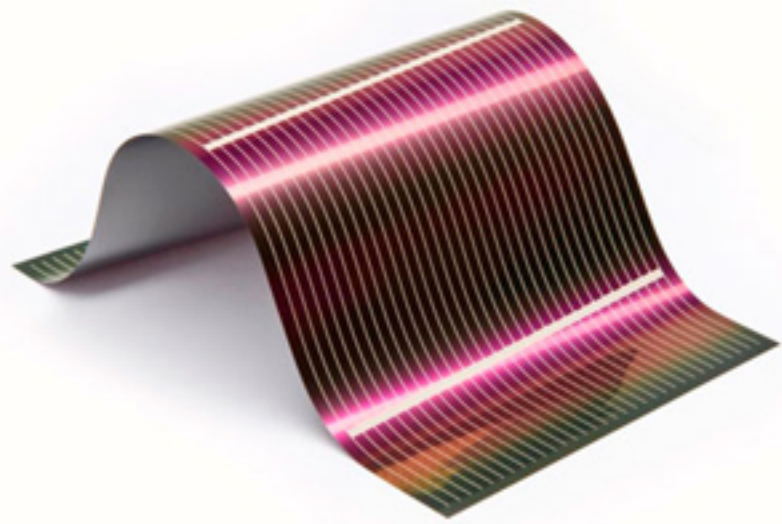

Unique Applications

http://solarcellcentral.com/solar_page.html

<http://solar.calfinder.com/blog/solar-research/cigs-solar-record-efficiency/>

Module Layer

Layer Options

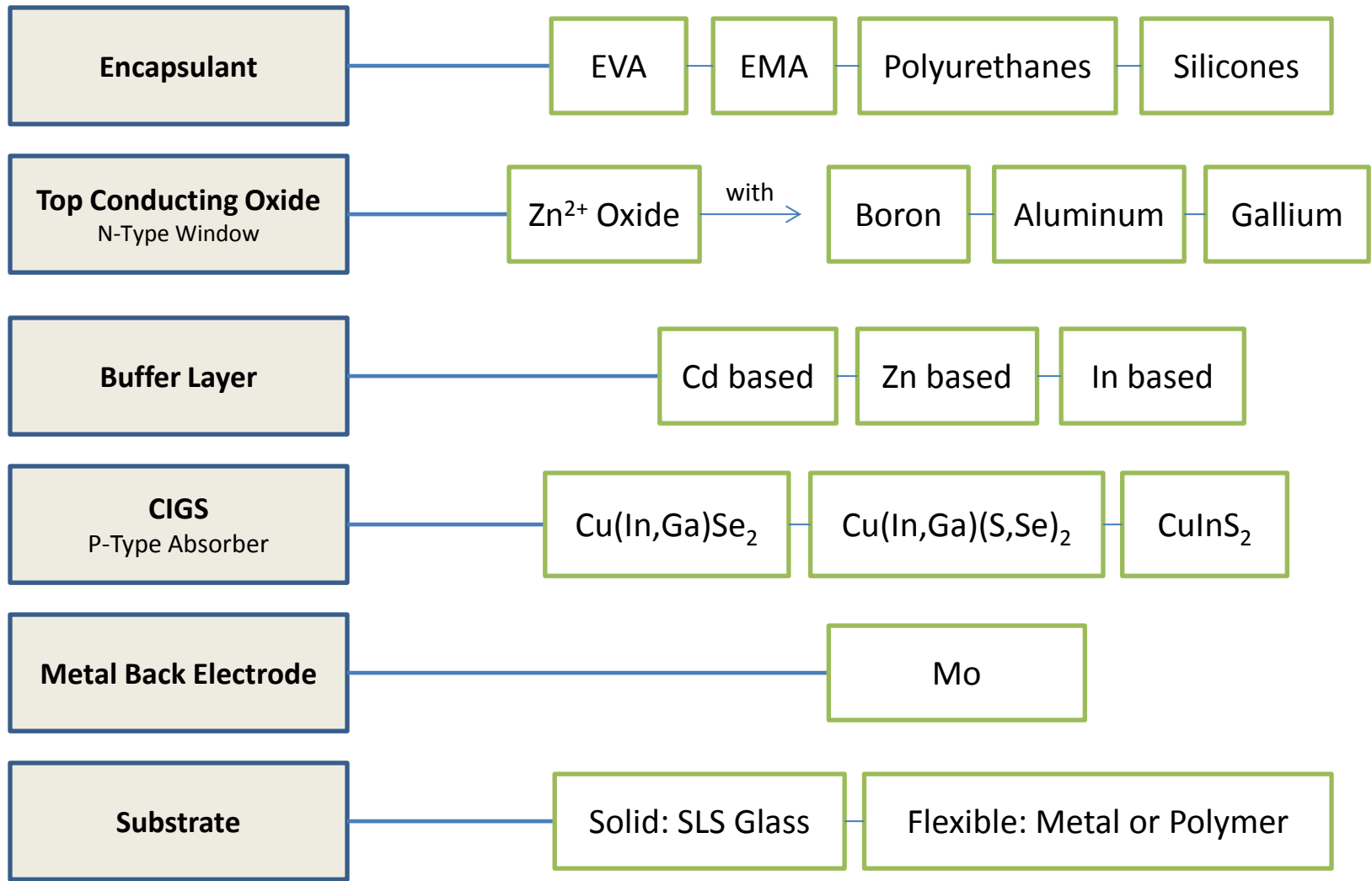

*EVA: Ethylene Vinyl Acetate, EMA: Ethylene Methacrylic Acid

*SLS: Soda Lime Glass

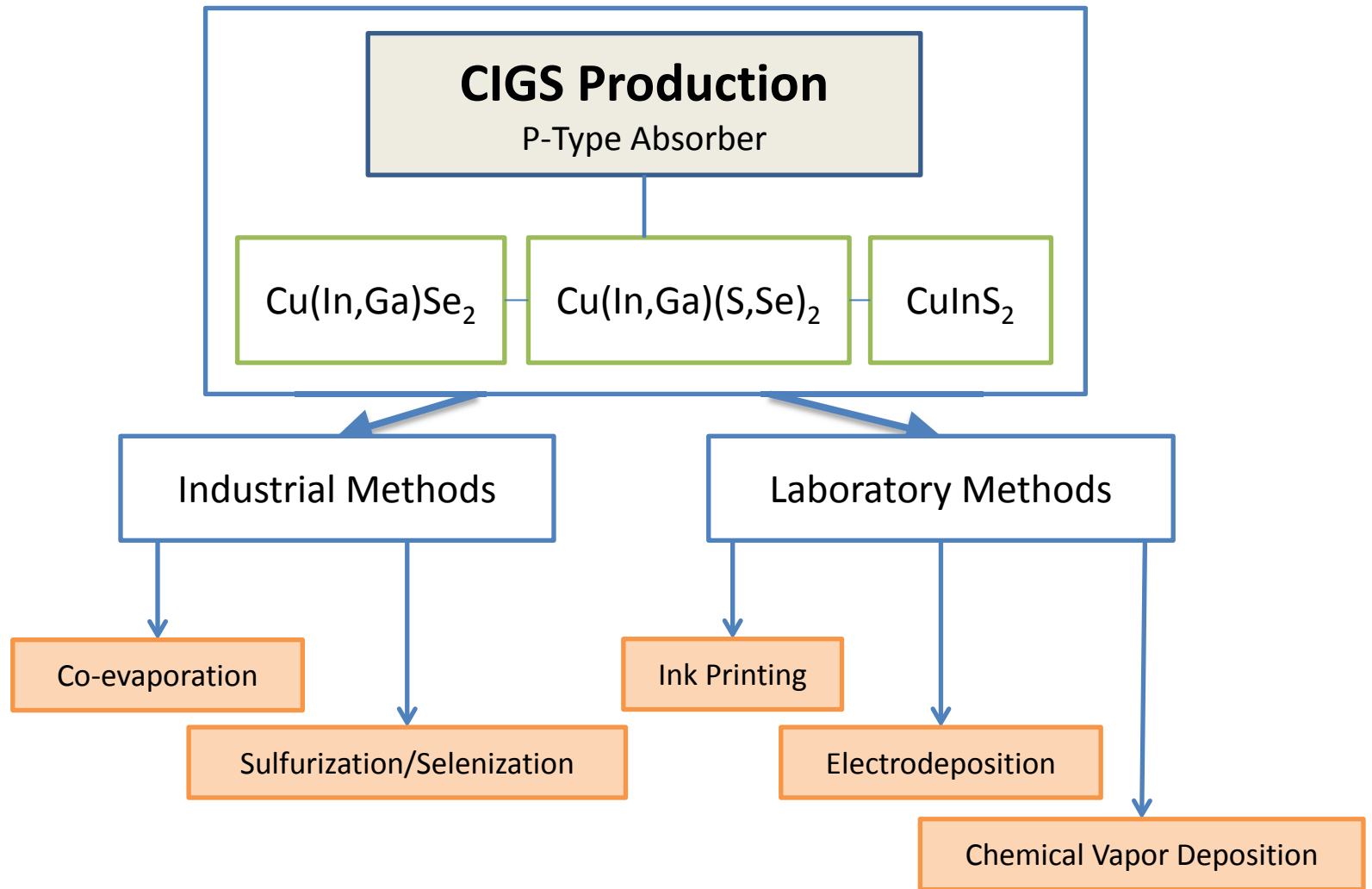

CHA Tools: TPI and Green Screen for Safer Chemicals[®]

Priority Human Health Effects (PE)	Human Health Effects (HH)	Ecotoxicity (Eco)	Environmental Fate (EF)	Physical Hazards (Phy)
Carcinogenicity (C)	Acute Toxicity (AT)	Acute Aquatic Toxicity (AA)	Persistence (P)	Explosivity (E)
Mutagenicity (M)	Irritation and Corrosion (IC)	Chronic Aquatic Toxicity (CA)	Bioaccumulation (B)	Flammability (F)
Reproductive (R)	Skin/Eye Sensitization (S)			
Developmental (D)	Immune System effects (IS)			
Endocrine Disruption (ED)	Systemic Organ Toxicity (SOT)			
Neurological (N)				

Utilizes 17 hazard traits from United Nations Globally Harmonized System (GHS)

*CHA: Chemical Hazard Assessment



CHA Tools: Green Screen

When all hazard traits are accounted for use iterative scheme to determine final hazard benchmark

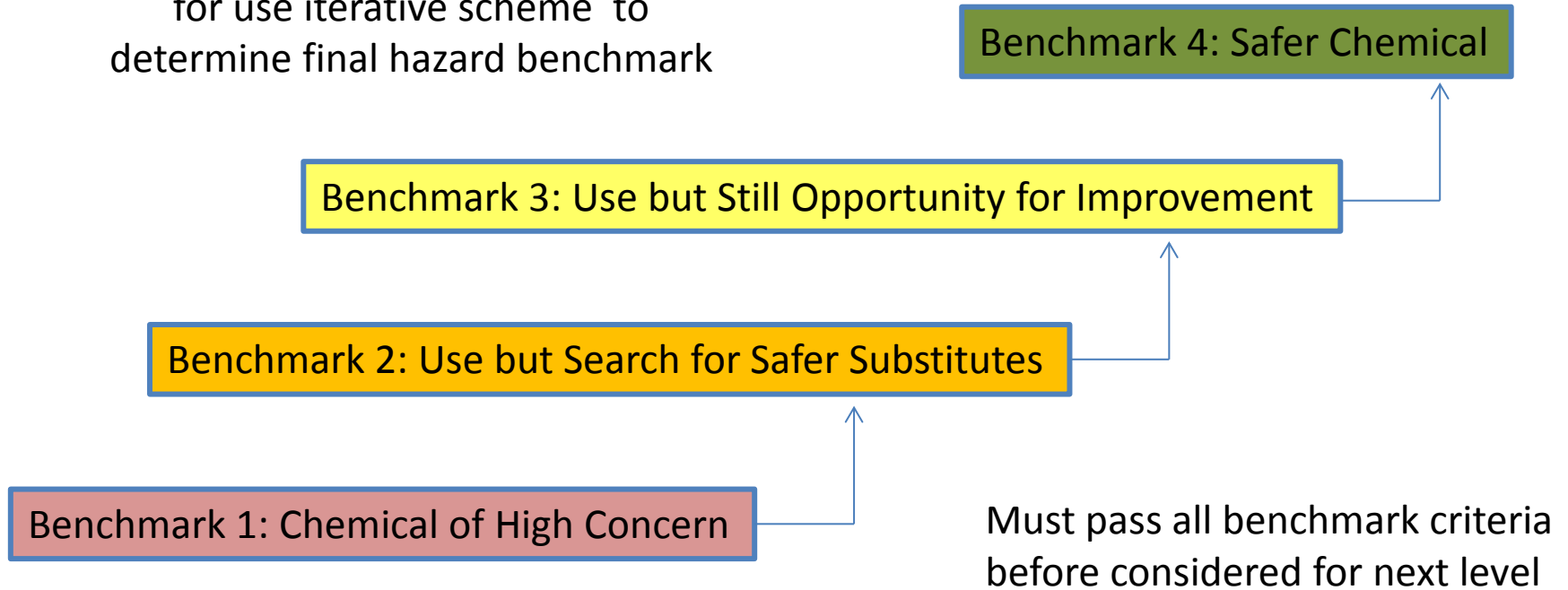

Substance Level CHA Example: Green Screen of CdS

	PE						HH					Eco		EF		Phy	
CAS #/Material	C	M	R	D	ED	N	AT	IC	S	IS	SOT	AA	CA	P	B	E	F
1306-23-6/ CdS																	

Use GHS and other national and international standardized hazard classification systems to determine relative hazard of each trait

Substance Level CHA Example: Green Screen of CdS

	PE						HH					Eco		EF		Phy	
CAS #/Material	C	M	R	D	ED	N	AT	IC	S	IS	SOT	AA	CA	P	B	E	F
1306-23-6/ CdS	1A	3	2	ND	ND	1	4	2	2	ND	1	1	1	--	--	4	4

Use GHS and other national and international standardized hazard classification systems to determine relative hazard of each trait

*ND: Not Detectable or No Data

Substance Level CHA Example: Green Screen of CdS

CAS #/Material	PE						HH					Eco		EF		Phy	
	C	M	R	D	ED	N	AT	IC	S	IS	SOT	AA	CA	P	B	E	F
1306-23-6/ CdS	1A	3	2	ND	ND	1	4	2	2	ND	1	1	1	--	--	4	4

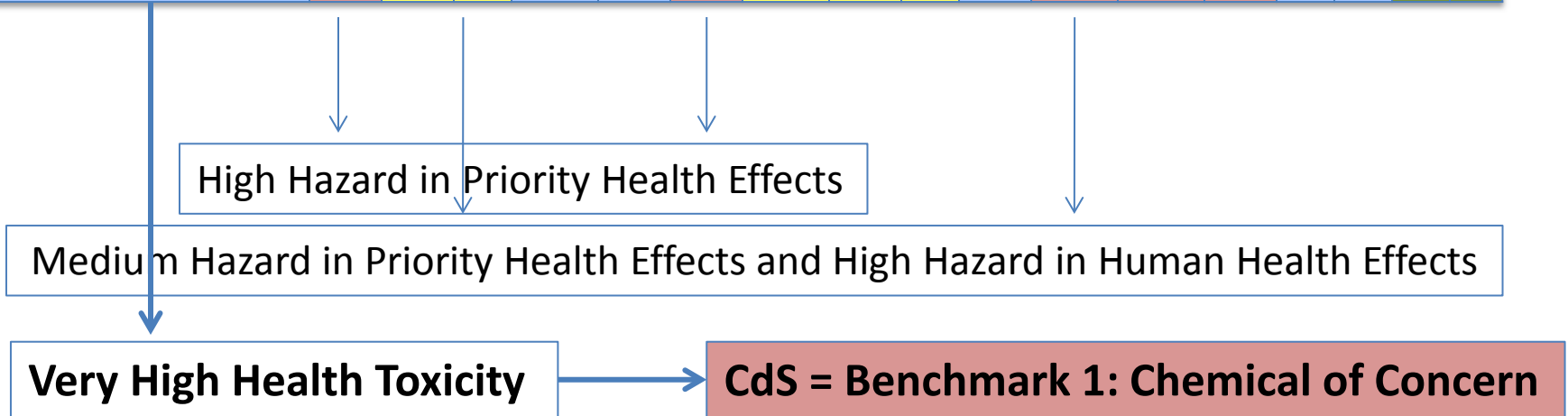

*CHA: Comparative Hazard Assessment

Process Level CHA Example: CIGS Deposition

CIGS Deposition Process		GS-Based Benchmark frequency				TPI score frequency			
Type of Processing	Specific Deposition Method	4	3	2	1	low	mid	high	very high
Industrial Process	Coevaporation	0	1	4	0	1	1	2	1
Ink Printing	Spray Pyrolysis of CuInS_2	0	0	2	1	0	0	3	0
Electrodeposition	Kapmann Method	1	1	4	2	2	0	5	1
Industrial Process	Sulfurization/ Selenization	1	1	4	1	1	1	3	1
Chemical Vapor Deposition	AP-MOCVD	0	0	6	1	3	0	2	1
Electrodeposition	Kapmann Method with Ammonia	1	1	4	3	2	1	5	1

Hazard **Low** \longrightarrow **High** **Low** \longrightarrow **High**

Green Engineering Case Studies: Methods and Applications









- Economic Assessment
 - Materials Recovery Facility for Computer Displays (CRTs)
 - Cell Phone Disassembly
- Toxicity Potential and Chemical Hazard Assessment
 - Utility Meter Products
 - Thin Film Photovoltaics (CIGS)
- Hazardous Waste, Resource Depletion and Toxicity Potentials
 - Light Emitting Diodes (LEDs)
 - Artificial Lighting (LEDs, CFLs, Incandescent)

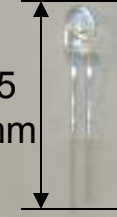

3. Materials and Methods

3.1. Materials

○ Small LEDs

Sample Name (color/intensity)	Red /Low	Red /High	Yellow /Low	Yellow /High	Green /Low	Green /High	Blue /Low	Blue /High	White
LED Color	Red	Red	Yellow	Yellow	Green	Green	Blue	Blue	White
Luminous Intensity (mcd)	150	6000	50	9750	50	5000	400	900	10000
Average Weight (g)	0.3098	0.2792	0.3130	0.2822	0.3114	0.2984	0.2982	0.3001	0.3068
Figure									

3. Materials and Methods

3.1. Materials

○ Bulbs



	Incandescent Bulb	CFL Bulb	LED Bulb
Wattage (W)	60	13	7.3
Luminous Intensity (lumens)	860	800	280
CRI (Color Rendering Index)	100	80	80
Color Temperature	3000*	2700	3000-3500
Lifetime (hours)	1000	10,000	50,000
Working Voltage (V)	120	120	85-265
Weight (g)	26	58	172

4. Results and Discussion

4.1. Leachability Test: **Small LEDs**

○ TCLP results for U.S. EPA hazardous waste regulation

Substance	TCLP Threshold	LED (color/intensity)								
		Red /Low	Red /High	Yellow /Low	Yellow /High	Green /Low	Green /High	Blue /Low	Blue /High	White
Aluminum	N/A	-	-	-	-	-	-	-	-	-
Antimony	N/A	-	-	-	-	-	-	-	-	-
Arsenic	5.0	-	-	-	-	-	-	-	-	-
Barium	100.0	-	-	-	-	-	-	-	-	-
Cerium	N/A	-	-	-	-	-	-	-	-	-
Chromium	5.0	-	-	-	-	-	-	-	-	-
Copper	N/A	-	-	-	-	-	-	-	-	-
Gadolinium	N/A	-	-	-	-	-	-	-	-	-
Gallium	N/A	-	-	-	-	-	-	-	-	-
Gold	N/A	-	-	-	-	-	-	-	-	-
Indium	N/A	-	-	-	-	-	-	-	-	-
Iron	N/A	332.5	178.3	206.0	163.5	211.8	161.8	178.5	130.8	202.3
Lead	5.0	186	-	-	-	-	-	-	-	-
Mercury	0.2	-	-	-	-	-	-	-	-	-
Nickel	N/A	-	-	-	-	-	-	-	-	-
Phosphorus	N/A	-	-	-	-	-	-	-	-	-
Silver	5.0	-	-	-	-	-	-	-	-	-
Tungsten	N/A	-	-	-	-	-	-	-	-	-
Yttrium	N/A	-	-	-	-	-	-	-	-	-
Zinc	N/A	-	-	-	-	-	-	-	-	-

4. Results and Discussion

4.1. Leachability Test: **Small LEDs**

○ TTLC results for State of California hazardous waste regulation

Substance	TTLC Threshold	LED (color/intensity)								
		Red /Low	Red /High	Yellow /Low	Yellow /High	Green /Low	Green /High	Blue /Low	Blue /High	White
Aluminum	N/A	97.0	158.0	104.0	156.0	79.6	156.0	153.0	73.4	84.5
Antimony	500	15.4	2.0	2.8	1.9	3.6	2.5	1.3	1.5	25.9
Arsenic	500	11.8	111.0	8.0	84.6	7.8	15.2	5.7	5.4	-
Barium	10000	-	-	-	-	-	-	-	-	-
Cerium	N/A	-	-	-	-	-	-	-	-	-
Chromium	500(VI);2500(III)	138.0	28.6	32.7	27.9	84.1	49.3	50.9	30.3	65.9
Copper	2500	87.0	3818.0	956.0	2948.0	1697.0	3702.0	3892.0	2153.0	31.8
Gadolinium	N/A	-	-	-	-	-	-	-	-	-
Gallium	N/A	135.6	95.0	63.8	79.1	75.6	3.1	2.1	1.5	3.8
Gold	N/A	39.8	45.8	30.5	30.1	40.2	176.3	32.5	118.6	115.9
Indium	N/A	3.4	1.7	-	-	2.5	-	-	-	-
Iron	N/A	285558.2	363890.8	300905.6	398630.4	310720.6	395652.2	339234.5	256499.3	311303.6
Lead	1000	8103.0	8.9	7.7	-	5.0	-	-	-	-
Mercury	20	-	-	-	-	-	-	-	-	-
Nickel	2000	4797.0	2054.0	1541.0	2192.0	2442.0	2930.0	1564.0	1741.0	4083.0
Phosphorus	N/A	114.2	-	58.4	-	78.5	91.8	79.1	84.3	110.8
Silver	500	430.0	409.0	248.0	336.0	270.0	306.0	418.0	721.0	520.0
Tungsten	N/A	-	-	-	-	-	-	-	-	-
Yttrium	N/A	-	-	-	-	-	-	-	-	-
Zinc	5000	48.2	66.2	36.5	63.6	41.8	62.5	42.6	36.7	49.2

- "N/A" : Not Applicable, "-" : Not Detected

4. Results and Discussion

4.1. Leachability Test: **Bulbs**

- TCLP results for U.S. EPA hazardous waste regulation

Substance	TCLP Threshold	Incandescent Bulb	CFL Bulb	LED Bulb	
				Ground to less than 2 mm	Less than 9.5 mm
Aluminum	N/A	13.3	39.8	59.8	8.9
Antimony	N/A	ND	ND	ND	ND
Arsenic	5	ND	ND	ND	ND
Barium	100	0.3	2.4	3.3	0.1
Cerium	N/A	47.9	7.6	19.6	0.003
Chromium	5	ND	ND	ND	ND
Copper	N/A	ND	4.3	3.1	0.027
Gadolinium	N/A	0.2	0.1	0.1	ND
Gallium	N/A	3.6	0.7	1.7	ND
Gold	N/A	ND	ND	ND	ND
Indium	N/A	ND	ND	ND	ND
Iron	N/A	59.1	967	1180	1.6
Lead	5	0.1	132	44.4	ND
Mercury	0.2	ND	ND	ND	ND
Nickel	N/A	14.1	7.3	17.0	0.2
Phosphorus	N/A	ND	ND	ND	ND
Silver	5	ND	ND	ND	ND
Tungsten	N/A	ND	ND	ND	ND
Yttrium	N/A	7.1	64.9	26.3	ND
Zinc	N/A	0.9	16.0	175	4.7

- "N/A" : Not Applicable, "-" : Not Detected

4. Results and Discussion

4.1. Leachability Test: **Bulbs**

○ TTLC results for State of California hazardous waste regulation

Substance	TTLC Threshold	Incandescent Bulb	CFL Bulb	LED Bulb
Aluminum	N/A	40,100	31,700	947,000
Antimony	500	ND	117	123
Arsenic	500	ND	2.6	ND
Barium	10000	4.1	17.8	364
Cerium	N/A	9.4	9.6	7.8
Chromium	500 (VI); 2500 (III)	5.8	1.1	120
Copper	2500	942	111,000	31,600
Gadolinium	N/A	ND	0.6	0.1
Gallium	N/A	7.9	6.0	108
Gold	N/A	ND	ND	2.2
Indium	N/A	ND	ND	ND
Iron	N/A	372	12,800	12,300
Lead	1000	6.9	3860	16.7
Mercury	20	0.1	18.3	0.4
Nickel	2000	188	120	151
Phosphorus	N/A	ND	222	127
Silver	500	16.2	12.2	159
Tungsten	N/A	24.4	1.4	1.2
Yttrium	N/A	0.6	2540	1.7
Zinc	5000	320	34,500	4540

- "N/A" : Not Applicable, "ND" : Not Detected

4. Results and Discussion

4.3. Toxicity Potential: **Bulbs**

- Comparison of the incandescent, CFL, and LED bulbs taking into account design lifetimes (1000, 10,000, 50,000 hr, respectively).

Environmental Impact Assessment Category and Method		Incandescent Bulb	CFL Bulb	LED Bulb	
Resource Depletion Potential	CML 2001	1	3	3	
	EPS 2000	1	5	2	
Hazard-based Toxicity Potential	TLV-TWA	1	4	3	
	PEL-TWA	1	13	3	
	REL-TWA	1	8	2	
	TPI	1	16	2	
Life Cycle Impact (USEtox™)-based Toxicity Potential	Human-Toxicity Potential	Urban Air	1	22	2
		Rural Air	1	22	2
		Freshwater	1	25	2
		Sea Water	1	22	2
		Natural Soil	1	26	2
		Agricultural Soil	1	22	2
	Eco-toxicity Potential	Urban Air	1	22	3
		Rural Air	1	22	3
		Freshwater	1	22	3
		Sea Water	1	23	2
		Natural Soil	1	22	3
		Agricultural Soil	1	22	3

- The CFL and LED bulbs have higher resource depletion and toxicity potentials.
- The CFL bulb exhibits higher toxicity potentials than the LED bulb.
- The lower potentials of LED bulb are mainly due to the longer life of LED bulb.

Concluding Remarks

- The environmental and human health impacts of engineered products can be reduced through the application of green engineering principles.
- Various methods can be implemented to guide greener design, including economic impact assessment; life cycle assessment; hazardous waste, resource depletion and toxicity potential; and chemical hazard assessment.
- Implementation of these methods early in the design phase maximizes the potential benefit to society while also maximizing engineering functionality.



Thanks for joining us!

For more educational webinars
or to learn about the GC3:

www.greenchemistryandcommerce.org

